

# EZ-ZONE<sup>®</sup> PM

## User's Guide



## Limit Controller Models



1241 Bundy Boulevard., Winona, Minnesota USA 55987  
Phone: +1 (507) 454-5300, Fax: +1 (507) 452-4507 <http://www.watlow.com>

0600-0057-0000 Rev. L

Made in the U.S.A.



April 2013

## Safety Information













We use note, caution and warning symbols throughout this book to draw your attention to important operational and safety information.

A “NOTE” marks a short message to alert you to an important detail.

A “CAUTION” safety alert appears with information that is important for protecting your equipment and performance. Be especially careful to read and follow all cautions that apply to your application.

A “WARNING” safety alert appears with information that is important for protecting you, others and equipment from damage. Pay very close attention to all warnings that apply to your application.

The electrical hazard symbol, ⚡ (a lightning bolt in a triangle) precedes an electric shock hazard CAUTION or WARNING safety statement.

Symbol	Explanation
	CAUTION – Warning or Hazard that needs further explanation than label on unit can provide. Consult User’s Guide for further information.
	ESD Sensitive product, use proper grounding and handling techniques when installing or servicing product.
	Unit protected by double/reinforced insulation for shock hazard prevention.
	Do not throw in trash, use proper recycling techniques or consult manufacturer for proper disposal.
	Enclosure made of Polycarbonate material. Use proper recycling techniques or consult manufacturer for proper disposal.
	Unit can be powered with either alternating current (ac) voltage or direct current (dc) voltage.
	Unit is a Listed device per Underwriters Laboratories®. It has been evaluated to United States and Canadian requirements for Process Control Equipment. UL 61010 and CSA C22.2 No. 61010. File E185611 QUYX, QUYX7. See: <a href="http://www.ul.com">www.ul.com</a>
	Unit is compliant with European Union directives. See Declaration of Conformity for further details on Directives and Standards used for Compliance.
	Unit has been reviewed and approved by Factory Mutual as a Temperature Limit Device per FM Class 3545 standard. See: <a href="http://www.fmglobal.com">www.fmglobal.com</a>
	Unit has been reviewed and approved by CSA International for use as Temperature Indicating-Regulating Equipment per CSA C22.2 No. 24. See: <a href="http://www.csa-international.org">www.csa-international.org</a>
	Unit has been reviewed and approved by ODVA for compliance with DeviceNet communications protocol. See: <a href="http://www.odva.org">www.odva.org</a>
	Unit has been reviewed and approved by ODVA for compliance with Ethernet/IP communications protocol. See: <a href="http://www.odva.org">www.odva.org</a>

## Warranty

The EZ-ZONE® PM is manufactured by ISO 9001-registered processes and is backed by a three-year warranty to the first purchaser for use, providing that the units have not been misapplied. Since Watlow has no control over their use, and sometimes misuse, we cannot guarantee against failure. Watlow's obligations hereunder, at Watlow's option, are limited to replacement, repair or refund of purchase price, and parts which upon examination prove to be defective within the warranty period specified. This warranty does not apply to damage resulting from transportation, alteration, misuse or abuse. The purchaser must use Watlow parts to maintain all listed ratings.

## Technical Assistance

If you encounter a problem with your Watlow controller, review your configuration information to verify that your selections are consistent with your application: inputs, outputs, alarms, limits, etc. If the problem persists, you can get technical assistance from your local Watlow representative (see back cover), by e-mailing your questions to [wintechsupport@watlow.com](mailto:wintechsupport@watlow.com) or by dialing +1 (507) 494-5656 between 7 a.m. and 5 p.m., Central Standard Time (CST). Ask for for an Applications Engineer. Please have the following information available when calling:

- Complete model number
- All configuration information
- User's Guide
- Factory Page

## Return Material Authorization (RMA)

1. Call Watlow Customer Service, (507) 454-5300, for a Return Material Authorization (RMA) number before returning any item for repair. If you do not know why the product failed, contact an Application Engineer or Product Manager. All RMA's require:
  - Ship-to address
  - Bill-to address
  - Contact name
  - Phone number
  - Method of return shipment
  - Your P.O. number
  - Detailed description of the problem
  - Any special instructions
  - Name and phone number of person returning the product.
2. Prior approval and an RMA number from the Customer Service Department is required when returning any product for credit, repair or evaluation. Make sure the RMA number is on the outside of the carton and on all paperwork returned. Ship on a Freight Prepaid basis.
3. After we receive your return, we will examine it and try to verify the reason for returning it.
4. In cases of manufacturing defect, we will enter a repair order, replacement order or issue credit for material returned. In cases of customer mis-use, we will provide repair costs and request a purchase order to proceed with the repair work.
5. To return products that are not defective, goods must be in new condition, in the original boxes and they must be returned within 120 days of receipt. A 20 percent restocking charge is applied for all returned stock controls and accessories.
6. If the unit is not repairable, you will receive a letter of explanation. and be given the option to have the unit returned to you at your expense or to have us scrap the unit.
7. Watlow reserves the right to charge for no trouble found (NTF) returns.

The EZ-ZONE PM Limit Controller User's Guide is copyrighted by Watlow Electric Inc., © April 2013 with all rights reserved.

EZ-ZONE PM is covered by U.S. Patent No. 6,005,577 and Patents Pending



# Table of Contents

<b>Chapter 1: Overview</b> .....	<b>3</b>
Standard Features and Benefits .....	3
A Conceptual View of the PM .....	4
<b>Chapter 2: Install and Wire</b> .....	<b>9</b>
Dimensions .....	9
Wiring .....	16
<b>Chapter 3: Keys and Displays</b> .....	<b>33</b>
Responding to a Displayed Messages .....	34
Attention Codes .....	34
<b>Chapter 4: Home Page</b> .....	<b>35</b>
Conventions Used in the Menu Pages .....	38
<b>Chapter 5: Operations Page</b> .....	<b>41</b>
Analog Input Menu .....	42
Digital Input/Output Menu .....	42
Limit Menu .....	43
Alarm Menu .....	43
<b>Chapter 6: Setup Page</b> .....	<b>46</b>
Analog Input Menu .....	48
Digital Input/Output Menu .....	50
Limit Menu .....	52
Output Menu .....	53
Alarm Menu .....	55
Function Key .....	58
Global Menu .....	58
Communications Menu .....	59
<b>Chapter 7: Factory Page</b> .....	<b>65</b>
Custom Menu .....	66
Lock Menu .....	66
Unlock Menu .....	68
Diagnostic Menu .....	68
Calibration Menu .....	69



# Table of Contents (cont.)

- Chapter 8: Features . . . . . 71**
  - Changing PM Limit Model Number to PM Express Limit . . . . . 72
  - Saving and Restoring User Settings . . . . . 73
  - Programming the Home Page . . . . . 73
  - Inputs . . . . . 73
  - Outputs . . . . . 76
  - Resetting a Tripped Limit . . . . . 77
  - Alarms . . . . . 77
  - Using Lockout and Password Security . . . . . 79
  - Modbus - Using Programmable Memory Blocks . . . . . 81
  - CIP - Communications Capabilities . . . . . 82
    - CIP Implicit Assemblies . . . . . 82
    - Modifying Implicit Assembly Members . . . . . 83
  - Profibus DP - (Decentralized Peripherals) . . . . . 83
  - Software Configuration . . . . . 84
- Chapter 9: Appendix . . . . . 87**
  - Troubleshooting Alarms, Errors and Control Issues . . . . . 87
  - Modbus - Programmable Memory Blocks . . . . . 90
  - CIP Implicit O to T (Originator to Target) Assembly Structure . . . . . 92
  - CIP Implicit T to O (Target to Originator) Assembly Structure . . . . . 92
  - Specifications . . . . . 100
  - Ordering Information for Enhanced Limit Controller Models . . . . . 102
  - Ordering Information for Limit Controller Models . . . . . 103
  - Index . . . . . 104
  - How to Reach Us . . . . . 108

# 1

## Chapter 1: Overview

The EZ-ZONE® PM takes the pain out of solving your thermal loop requirements.

Watlow's EZ-ZONE PM controllers offer options to reduce system complexity and the cost of control-loop ownership. You can also select from a number of serial communications options to help you manage system performance over a network.

It just got a whole lot easier to solve the thermal requirements of your system. Because the EZ-ZONE PM controllers are highly scalable, you only pay for what you need. So if you are looking for a Limit controller, the EZ-ZONE PM is the answer.

### Standard Features and Benefits

#### **EZ-ZONE configuration communications and software**

- Saves time and improves the reliability of controller set up

#### **FM Approved Over-under Limit with Auxiliary Outputs**

- Increases user and equipment safety for over-under temperature conditions

#### **Parameter Save & Restore Memory**

- Reduces service calls and down time

#### **Agency approvals: UL Listed, CSA, CE, RoHS, W.E.E.E. FM**

- Assures prompt product acceptance
- Reduces end product documentation costs
- FM approval on Limit Models
- Semi F47-0200

#### **P3T Armor Sealing System**

- NEMA 4X and IP66 offers water and dust resistance, can be cleaned and washed down (indoor use only)
- Backed up by UL 50 independent certification to NEMA 4X specification

#### **Three-year warranty**

- Demonstrates Watlow's reliability and product support

#### **Touch-safe Package**

- IP2X increased safety for installers and operators

#### **Removable cage clamp wiring connectors**

- Reliable wiring, reduced service calls
- Simplified installation

#### **EZ-Key/s**

- Programmable EZ-Key enables simple one-touch operation of repetitive user activities (PM4/6/8/9 only)

#### **Programmable Menu System**

- Reduces set up time and increases operator efficiency

#### **Full-featured Alarms**

- Improves operator recognition of system faults
- Control of auxiliary devices

# A Conceptual View of the PM

The flexibility of the PM's software and hardware allows a large range of configurations. Acquiring a better understanding of the EZ-ZONE® family controller's and their overall functionality and capabilities while at the same time planning out how the controller can be used will deliver maximum effectiveness in your application.

It is useful to think of the controller in three parts: inputs, procedures and outputs. Information flows from an input to a procedure to an output when the controller is properly configured. A PM limit controller can carry out several procedures at the same time, for instance, monitoring for several different alarm situations, monitoring and acting upon digital inputs and driving output devices such as lights and contactors. Each process needs to be thought out carefully and the controller's inputs, procedures and outputs set up properly.

---

## Inputs

The inputs provide the information that any given programmed procedure can act upon. Simply stated, this information may come from an operator pushing a button or from a sensor monitoring the temperature of a part being heated or cooled.

Each analog input typically uses a thermocouple or RTD to read the process temperature. It can also read volts, current or resistance, allowing it to use various devices to read humidity, air pressure, operator inputs and others values. The settings in the Analog Input Menu (Setup Page) for each analog input must be configured to match the device connected to that input.

Each digital input reads whether a device is active or inactive. A PM with digital input/output hardware includes two sets of terminals where each of which can be used as either an input or an output. Each pair of terminals must be configured to function as either an input or output with the direction parameter in the Digital Input/Output Menu (Setup Page).

The Function or EZ Key/s (PM4/6/8/9 only) on the front panel of the PM also operates as a digital input by toggling the function assigned to it in the Digital Input Function parameter in the Function Key Menu (Setup Page).

---

## Functions

Functions use input signals to calculate a value. A function may be as simple as reading a digital input to set a state to true or false, or reading a temperature to set an alarm state to on or off. Or, if a failure with the primary sensing device should occur the limit could trip a contactor removing power from the heating element to avoid damaging the load.

To set up a function, it's important to tell it what source, or instance, to use. For example, if the control is equipped with digital inputs they can be configured as an alarm. If configured as such the next step would be to define which of the four available alarm instances this digital input would be tied to. So, in this example the source would be Digital Input 5 or 6 where the instance would be selected as 1, 2, 3, or 4 corresponding to the alarm instances.

Keep in mind that a function is a user-programmed internal process that does not execute any action outside of the controller. To have any effect outside of the controller, an output must be configured to respond to a function.

---

## Outputs

Outputs can perform various functions or actions in response to information provided by a function, such as removal of the control voltage to a contactor; turning a light on or off; unlocking a door; or turning on a buzzer.

Assign an output to a Function in the Output Menu or Digital Input/Output Menu. Then select which instance of that function will drive the selected output. For example, in using a Limit Control an output can be configured to respond to an alarm, i.e., (instance 4) or to a limit condition.

You can assign more than one output to respond to a single instance of a function. For example, alarm 2 could be used to trigger a light connected to output 1 and a siren connected to digital output 5.

## Input Events and Output Events

Input events are internal states that are set by the digital inputs. Digital Input 5 provides the state of input event 1, and Digital Input 6 provides the state of input event 2. The setting of Digital Input Function (Setup Page, Digital Input/Output Menu) does not change the relationship between the input and the event. An input will still control the input event state, even if Digital Input Function is set to None.



# EZ-ZONE<sup>®</sup> PM Enhanced Limit PM4/6/8/9 Models - System Diagram (with communications options 2, 3, 5 or 6)

Universal Sensor Input, Configuration Communications,  
Red/Green 7-Segment Display

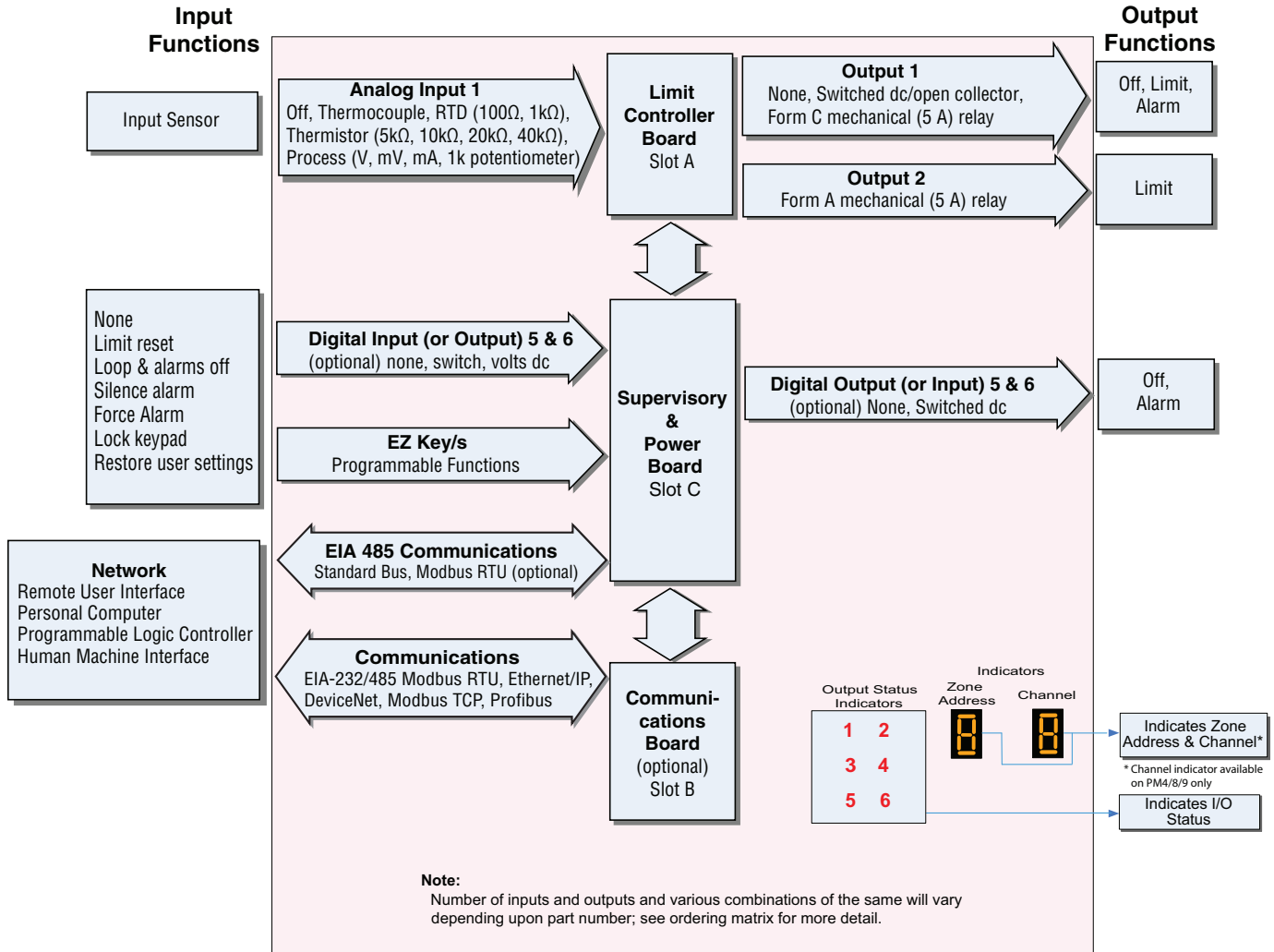

# EZ-ZONE<sup>®</sup> PM Enhanced Limit PM4/6/8/9 Models - Input/Output (no communications options 2, 3, 5 or 6)

Universal Sensor Input, Configuration Communications,  
Red/Green 7-Segment Display

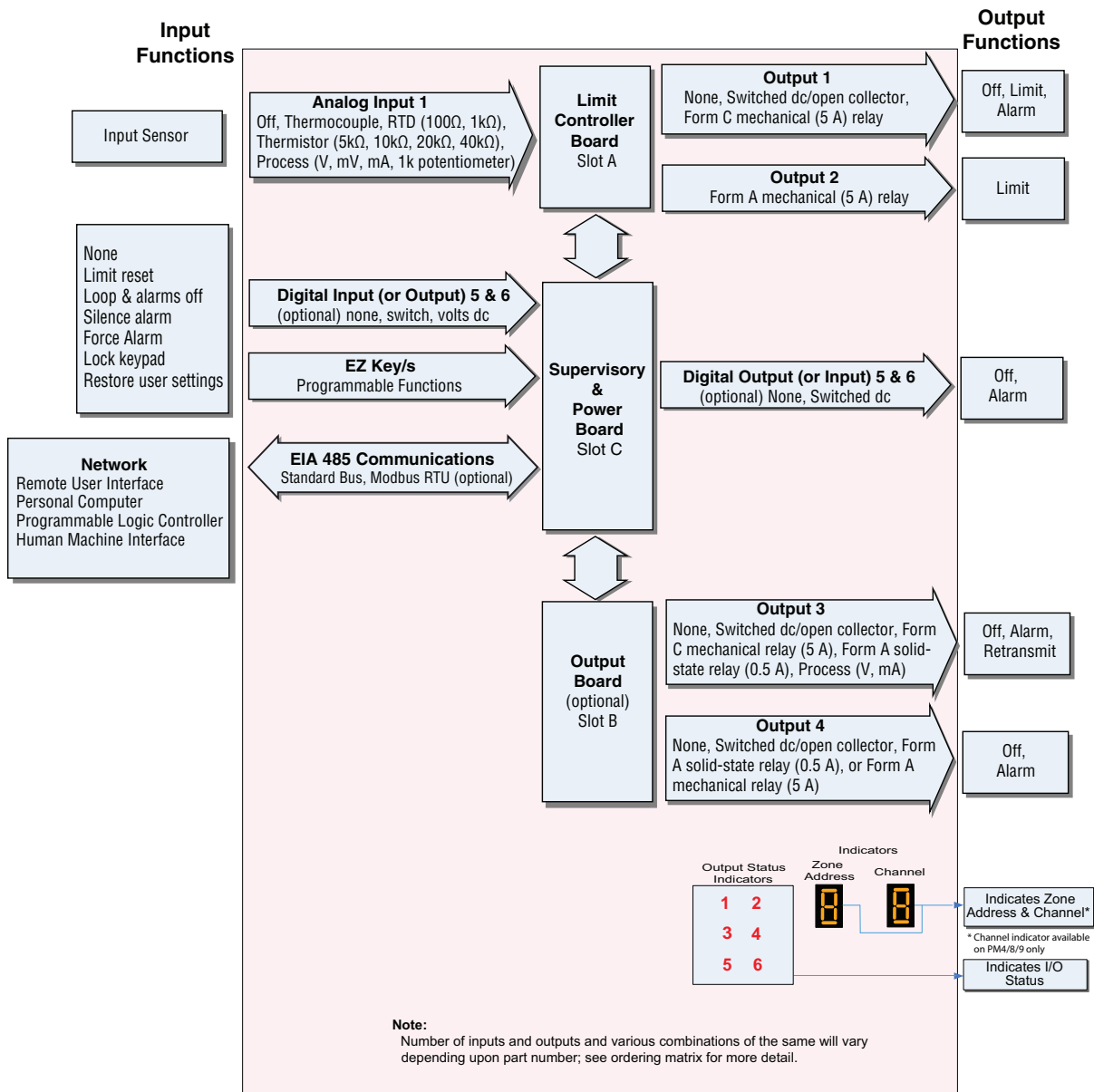

# EZ-ZONE<sup>®</sup> PM Limit All Models System Diagram

Universal Sensor Input, Configuration Communications,  
Red/Green 7-Segment Display

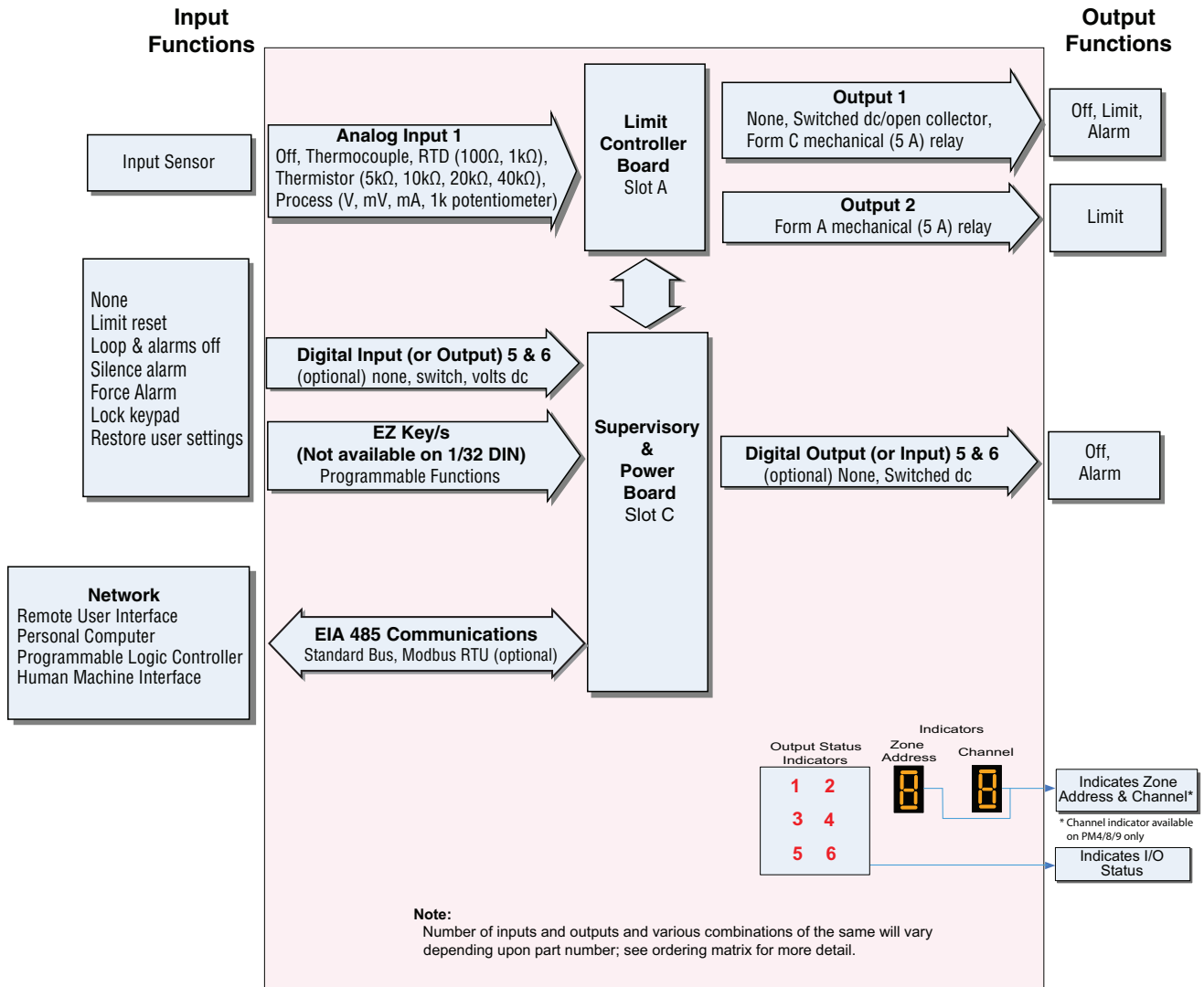

# 2

## Chapter 2: Install and Wire

### Dimensions

1/32 DIN

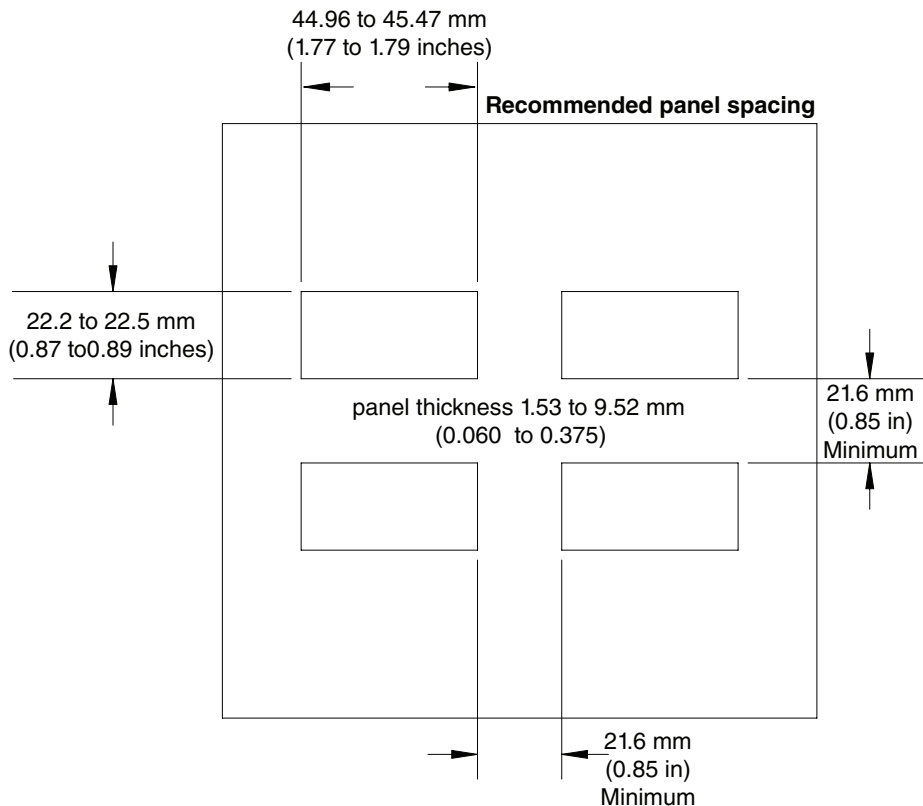
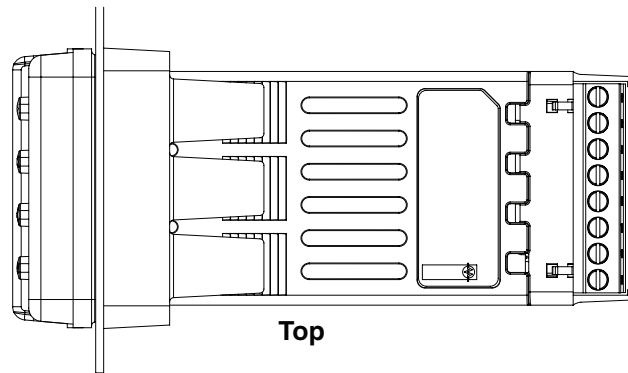
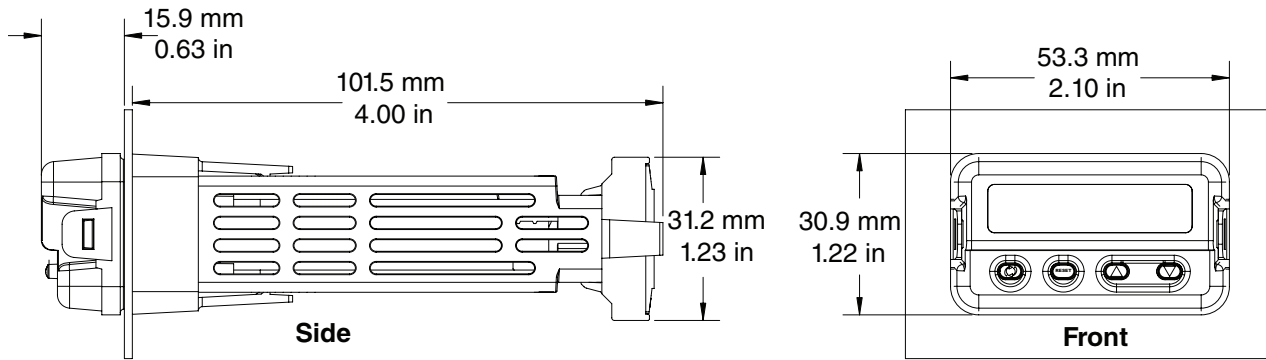

# 1/16 DIN

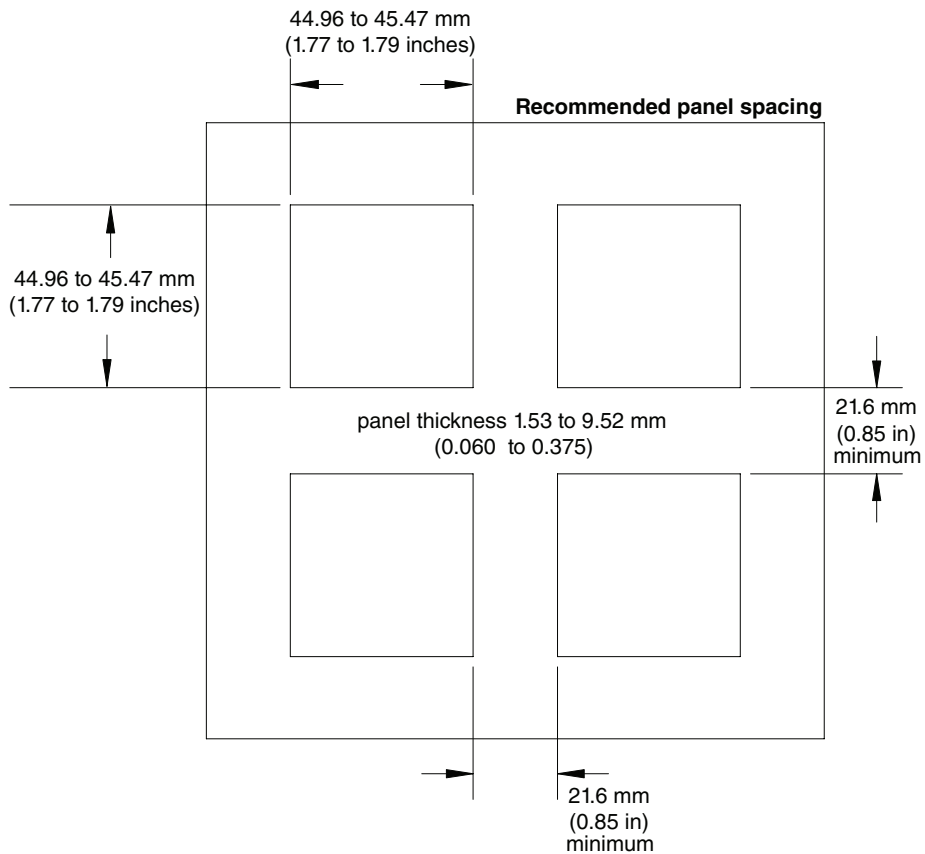
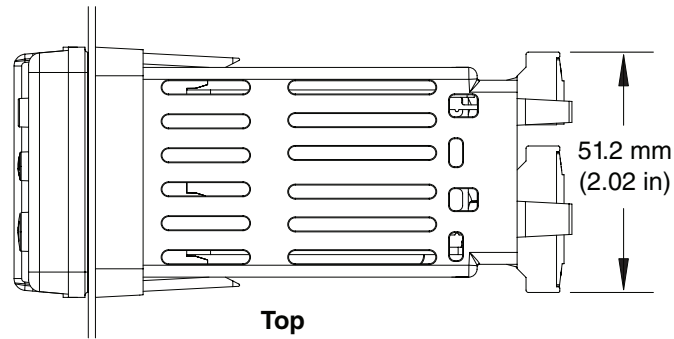
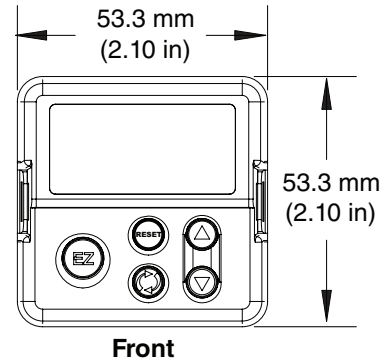
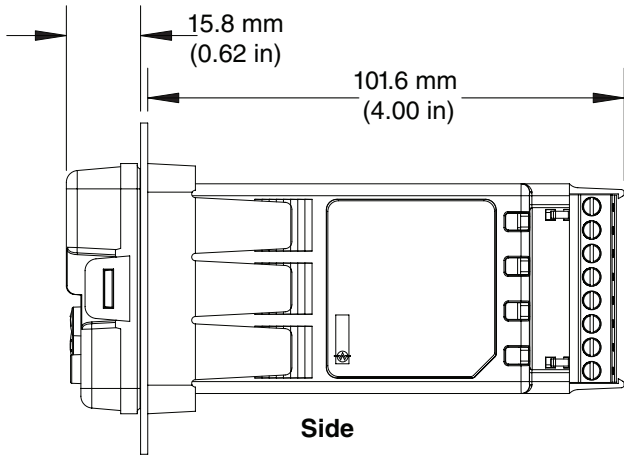

## 1/8 DIN (PM8) Vertical

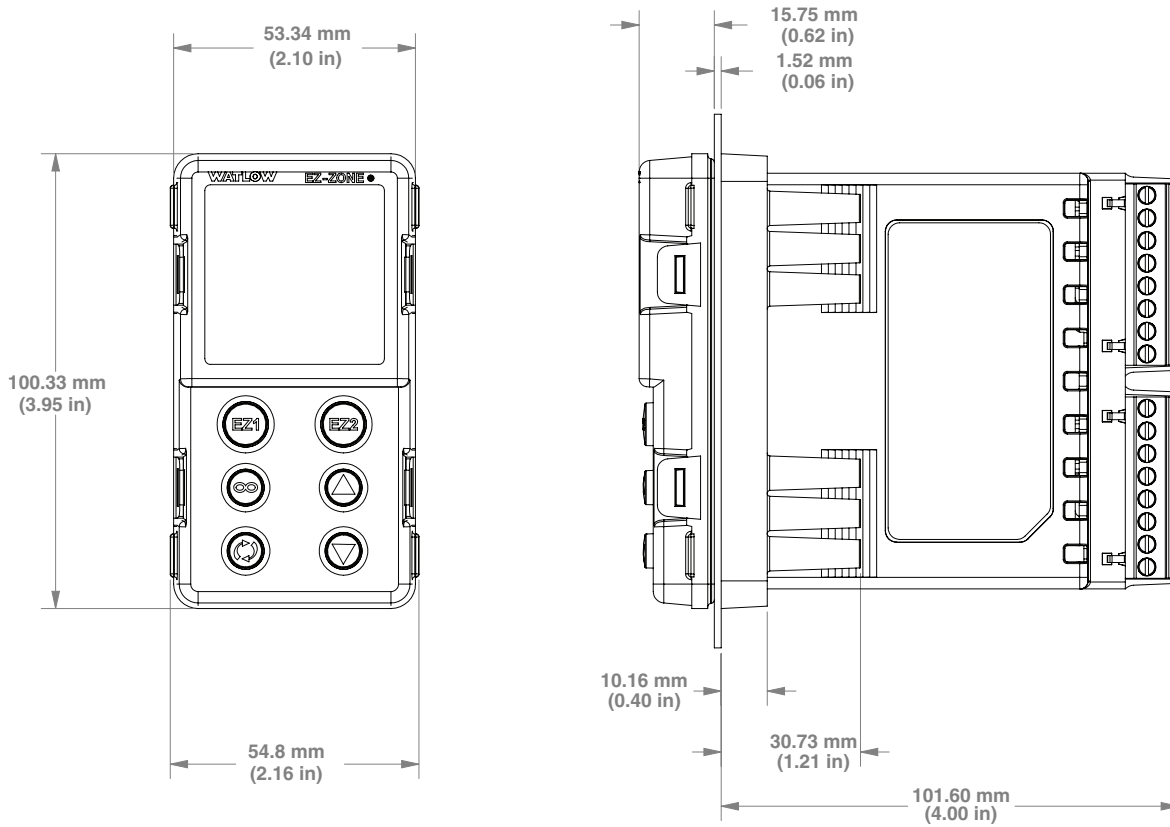

## 1/8 DIN (PM8) Vertical Recommended Panel Spacing

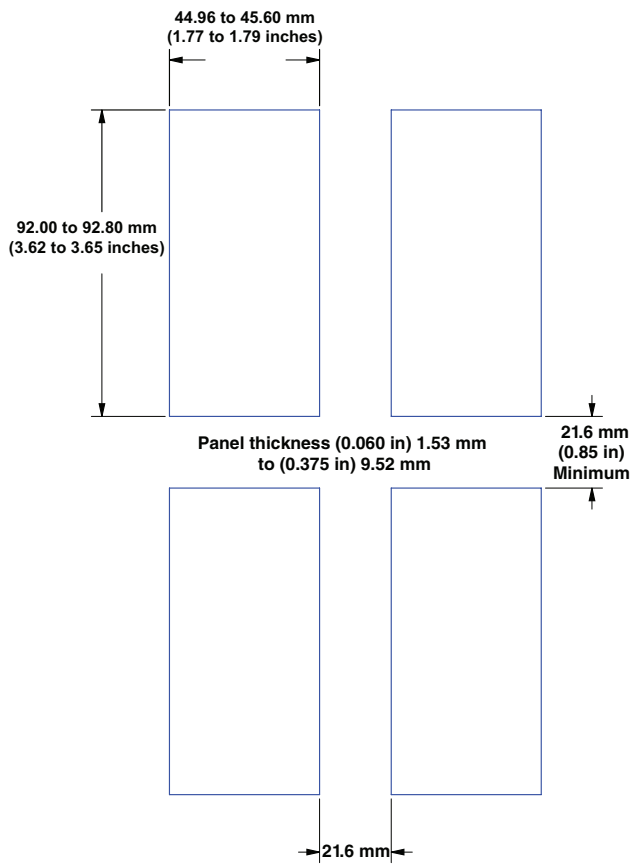

## 1/8 DIN (PM9) Horizontal

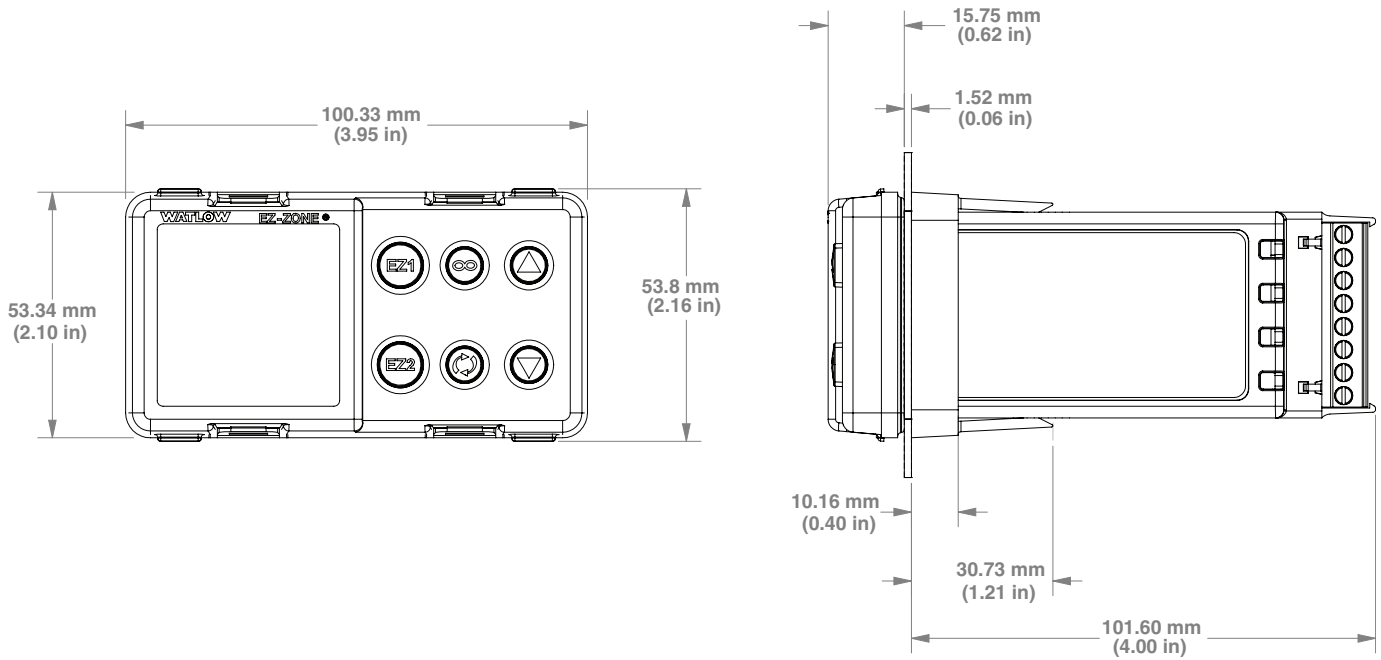

## 1/8 DIN (PM9) Horizontal Recommended Panel Spacing

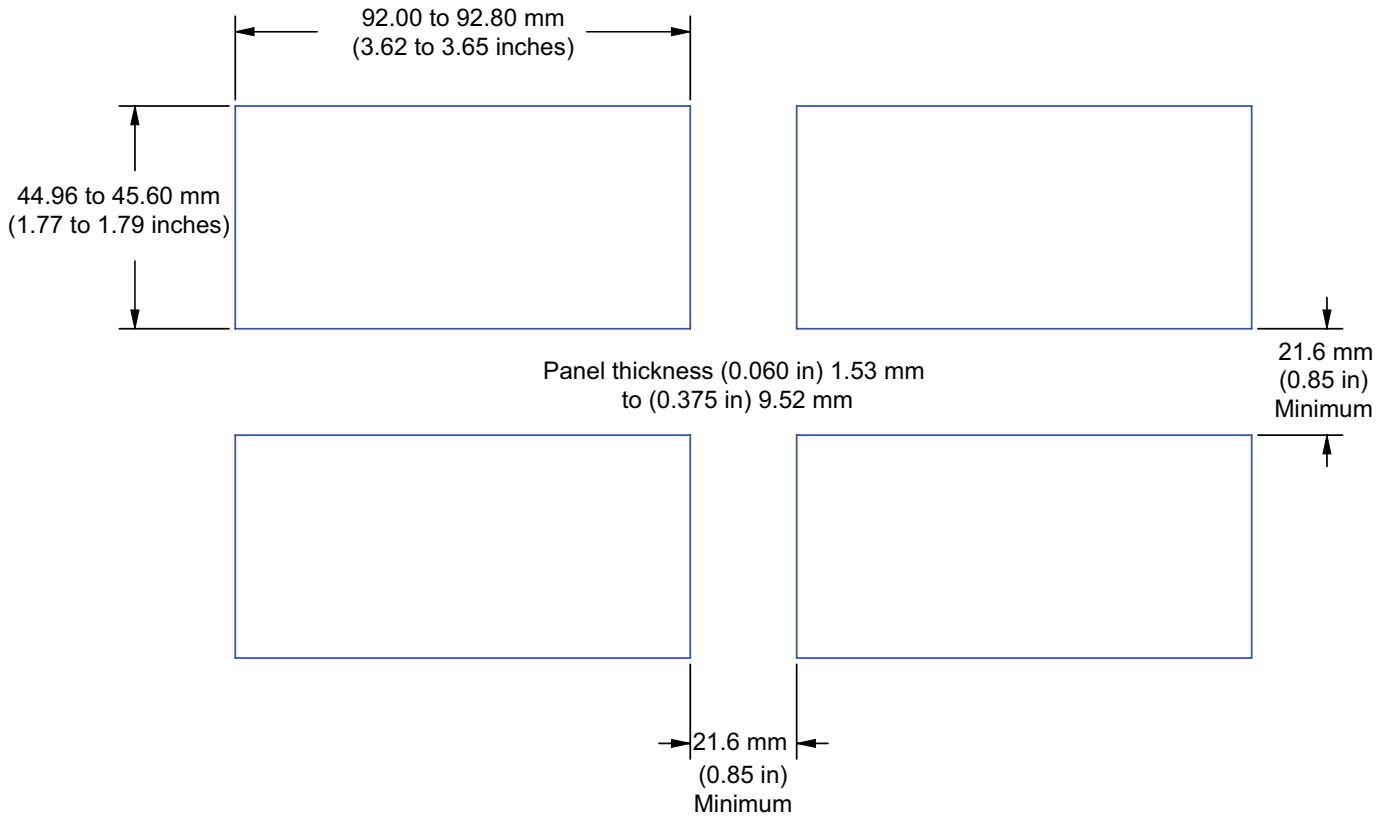

# 1/4 DIN (PM4)

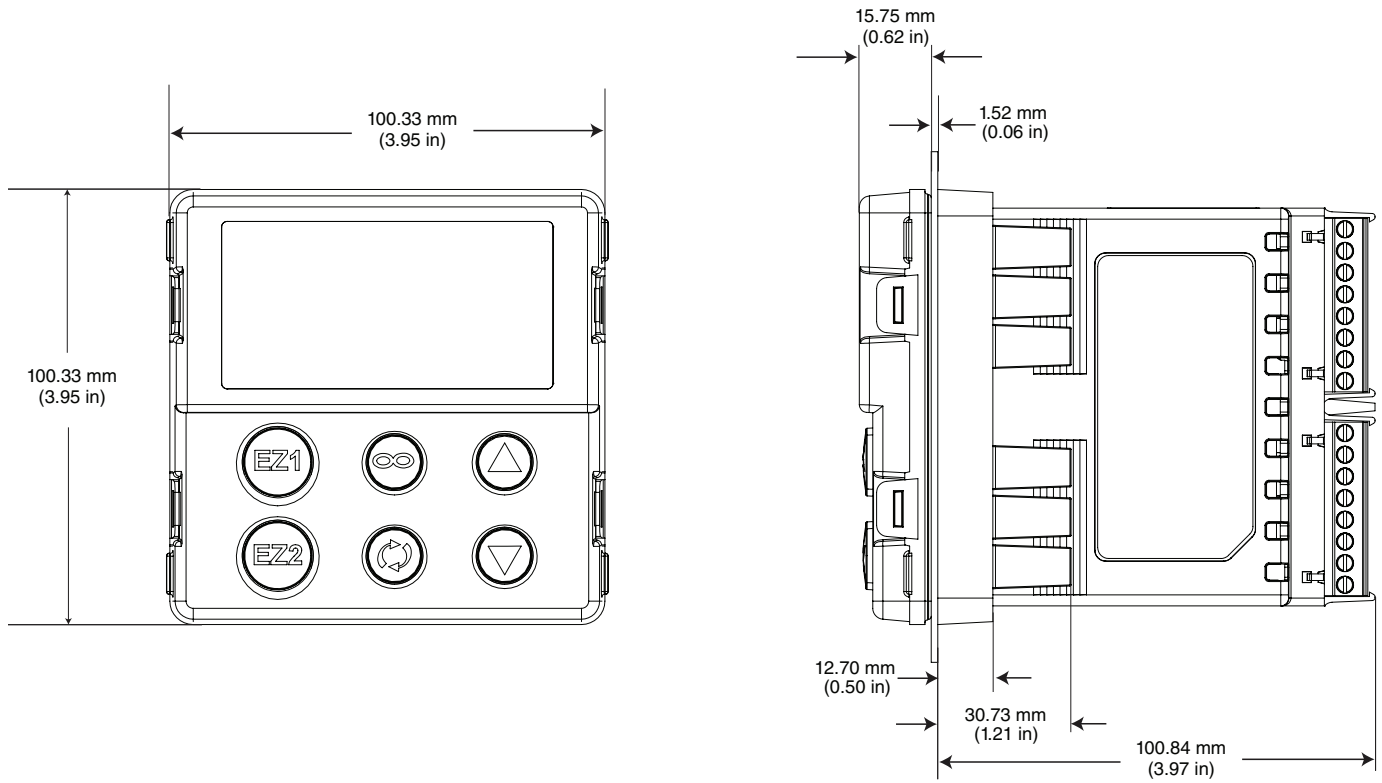

# 1/4 DIN (PM4) Recommended Panel Spacing

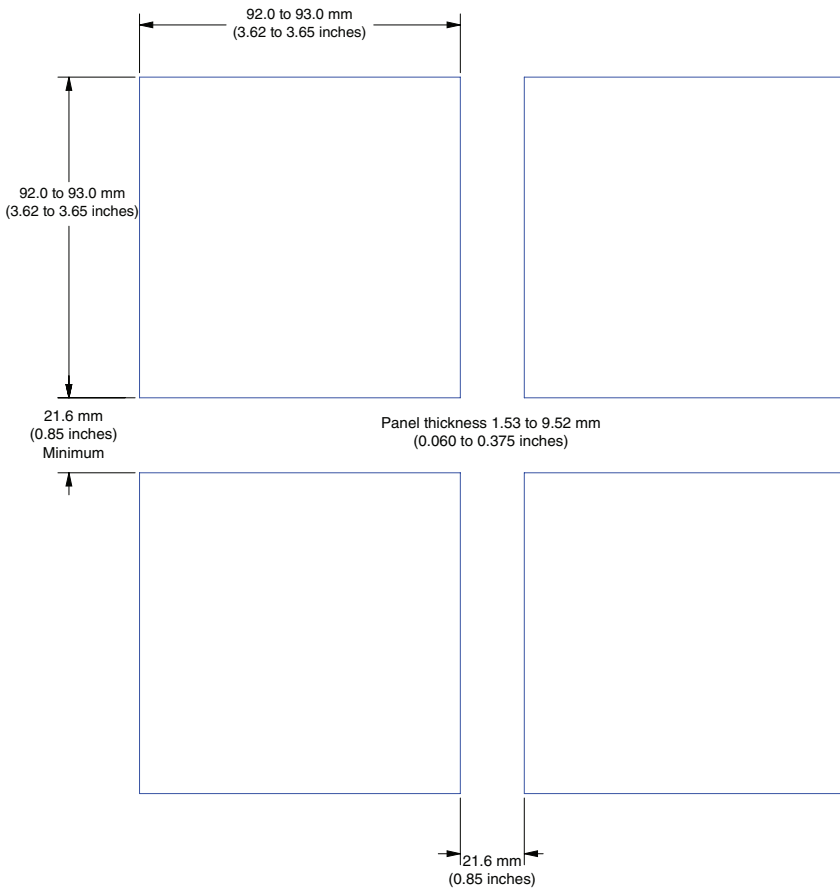



# Installation

1. Make the panel cutout using the mounting template dimensions in this chapter.

Insert the case assembly into the panel cutout.

2. While pressing the case assembly firmly against the panel, slide the mounting collar over the back of the controller.

If the installation does not require a NEMA 4X seal, simply slide together until the gasket is compressed.

3. For a NEMA 4X (UL50, IP66) seal, alternately place and push the blade of a screwdriver against each of the four corners of the mounting collar assembly. Apply pressure to the face of the controller while pushing with the screwdriver. Don't be afraid to apply enough pressure to properly install the controller. The seal system is compressed more by mating the mounting collar tighter to the front panel (see pictures above). If you can move the case assembly back and forth in the cutout, you do not have a proper seal. The tabs on each side of the mounting collar have teeth that latch into the ridges on the sides of the controller. Each tooth is staggered at a different depth from the front so that only one of the tabs, on each side, is locked onto the ridges at a time.

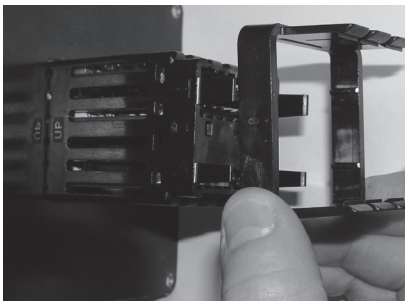
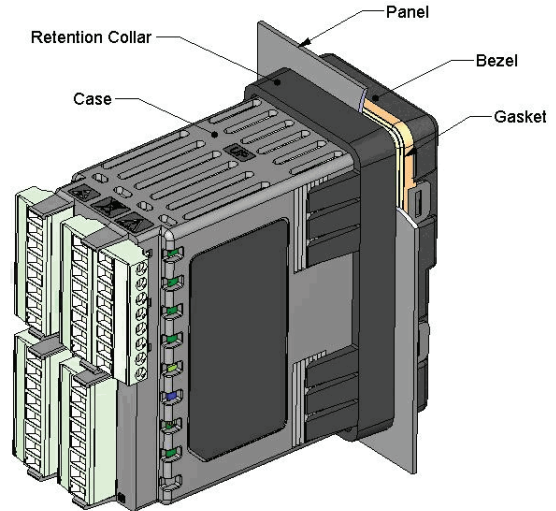

Slide the mounting collar over the back of the controller.

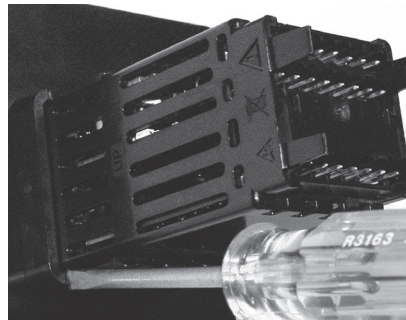

Place the blade of a screwdriver in any of the corner of the mounting collar assembly.

## Note:

There is a graduated measurement difference between the upper and lower half of the display to the panel. In order to meet the seal requirements mentioned above, ensure that the distance from the front of the top half of the display to the panel is 16 mm (0.630 in.) or less, and the distance from the front of the bottom half and the panel is 13.3 mm (0.525 in.) or less.

## Removing the Mounted Controller from Its Case

1. From the controller's face, pull out the tabs on each side until you hear it click.

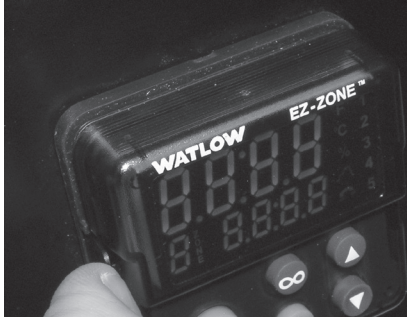

Pull out the tab on each side until you hear it click.

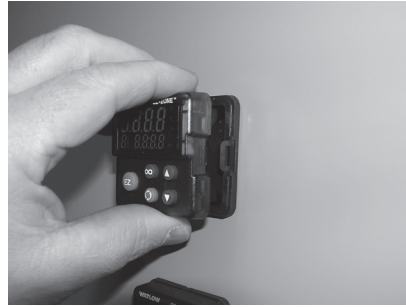

Grab the unit above and below the face and pull forward.

2. Grab the unit above and below the face with two hands and pull the unit out. On the PM4/8/9 controls slide a screwdriver under the pry tabs and turn.

## Returning the Controller to its Case

1. Ensure that the orientation of the controller is correct and slide it back into the housing.

### Note:

The controller is keyed so if it feels that it will not slide back in do not force it. Check the orientation again and reinsert after correcting.

2. Using your thumbs push on either side of the controller until both latches click.

## Chemical Compatibility

This product is compatible with acids, weak alkalis, alcohols, gamma radiation and ultraviolet radiation.

This product is not compatible with strong alkalis, organic solvents, fuels, aromatic hydrocarbons, chlorinated hydrocarbons, esters and ketones.

# Wiring

Slot A		Slot B		Slot E		
Output					Terminal Function	Configuration
1	2	3	4			
X1 W1 Y1		X3 W3 Y3			common (Any switched dc output can use this common.) dc- (open collector) dc+	Switched dc/open collector output 1: PM [4, 6, 8, 9] _ _ [C] _ _ _ _ AAA output 3: PM [4, 6, 8, 9] _ _ _ _ _ [C] _ AAA
			W4 Y4		dc- dc+	Switched dc output 4: PM [4, 6, 8, 9] _ _ _ _ _ [C] AAA
		F3 G3 H3			voltage or current - voltage + current +	Universal Process output 3: PM [4, 6, 8, 9] _ _ _ _ _ [F] _ AAA
L1 K1 J1		L3 K3 J3			normally open common normally closed	Mechanical Relay 5 A, Form C output 1: PM [4, 6, 8, 9] _ _ E _ _ _ _ AAA output 3: PM [4, 6, 8, 9] _ _ _ _ _ [E] _ AAA
	L2 K2		L4 K4		normally open common	Mechanical Relay 5 A, Form A output 2: PM [4, 6, 8, 9] _ _ _ J _ _ _ AAA output 4: PM [4, 6, 8, 9] _ _ _ _ _ [J] AAA
		L3 K3	L4 K4		normally open common	Solid-state Relay 0.5 A, Form A output 3: PM [4, 6, 8, 9] _ _ _ _ _ [K] _ AAA output 4: PM [4, 6, 8, 9] _ _ _ _ _ [K] AAA
<b>Communications</b>						
		CB CA CC CB CA C5 C3 C2	CB CA CC CB CA C5 C3 C2		Modbus RTU EIA-485 T+/R+ Modbus RTU EIA-485 T-/R- Modbus RTU EIA-485 common Modbus RTU EIA-485 T+/R+ Modbus RTU EIA-485 T-/R- Modbus RTU EIA-232 common Modbus RTU EIA-232 to DB9 pin 2 Modbus RTU EIA-232 to DB9 pin 3	Modbus RTU 232/485 Communications Slot B: PM6 _ _ _ _-[2] A A A AAA Slot E: PM [4, 8, 9] _ _ _ _-[2] A A A AAA
		V+ CH SH CL V-	V+ CH SH CL V-		DeviceNet™ power Positive side of DeviceNet™ bus Shield interconnect Negative side of DeviceNet™ bus DeviceNet™ power return	DeviceNet™ Communications Slot B: PM6 _ _ _ _-[5] A A A AAA Slot E: PM [4, 8, 9] _ _ _ _-[5] A A A AAA
		E8 E7 E6 E5 E4 E3 E2 E1	E8 E7 E6 E5 E4 E3 E2 E1		EtherNet/IP™ and Modbus TCP unused EtherNet/IP™ and Modbus TCP unused EtherNet/IP™ and Modbus TCP receive - EtherNet/IP™ and Modbus TCP unused EtherNet/IP™ and Modbus TCP unused EtherNet/IP™ and Modbus TCP receive + EtherNet/IP™ and Modbus TCP transmit - EtherNet/IP™ and Modbus TCP transmit +	Ethernet 10/100 supporting EtherNet/IP™ and Modbus TCP Slot B: PM6 _ _ _ _-[3] A A A AAA Slot E: PM [4, 8, 9] _ _ _ _-[3] A A A AAA
		VP B A DG trB B A trA	VP B A DG trB B A trA		Voltage Potential EIA-485 T+/R+ EIA-485 T-/R- Digital ground (common) Termination resistor B EIA-485 T+/R+ EIA-485 T-/R- Termination resistor A	Profibus Communications Slot B: PM6 _ _ _ _-[6] A A A AAA Slot E: PM [4, 8, 9] _ _ _ _-[6] A A A AAA
<b>Inputs</b>						
1						
T1 S1 R1					S2 (RTD) or current + S3 (RTD), thermocouple -, current -, volts - or potentiometer wiper, thermistor S1 (RTD), thermocouple + or volts +, thermistor, potentiometer	Universal Sensor input 1: all configurations
<b>Slot A</b>	<b>Slot B</b>	<b>Slot E</b>				

### Terminal Definitions for Slot C.

Slot C	Terminal Function	Configuration
98 99	power input: ac or dc+ power input: ac or dc-	all
CC CA CB	Standard Bus or Modbus RTU EIA-485 common Standard Bus or Modbus RTU EIA-485 T-/R- Standard Bus or Modbus RTU EIA-485 T+/R+	Standard Bus or Modbus PM _____-[1] ___ AAA
CF CD CE	Standard Bus EIA-485 common Standard Bus EIA-485 T-/R- Standard Bus EIA-485 T+/R+	PM _____-[A, 2 or 3] ___ AAA
B5 D6 D5	digital input-output common digital input or output 6 digital input or output 5	PM __ [2] ___- ___ AAA PM __ [4] ___- ___ AAA

**Back View  
Slot Orientation  
1/16 DIN PM6**

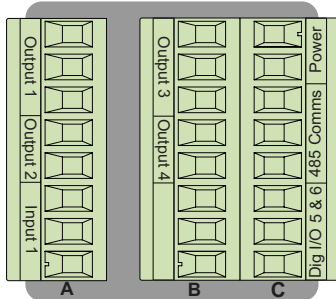

**Note:**

Slot B above can also be configured with a communications card.

**Back View  
Slot Orientation 1/8  
DIN Vertical PM8**

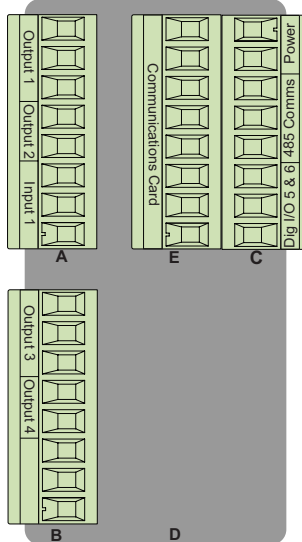

**Back View  
Slot Orientation  
1/32 DIN PM3**

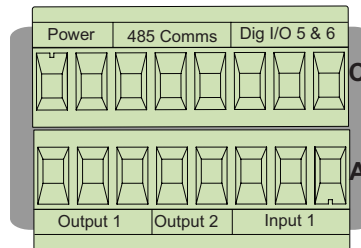

**Back View  
Slot Orientation  
1/8 DIN Horizontal PM9**

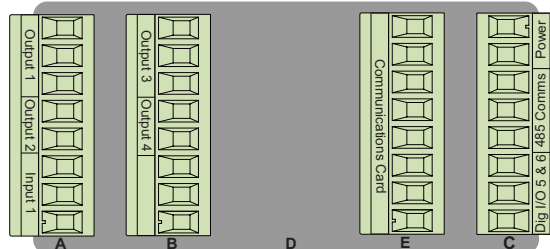

**Back View  
Slot Orientation  
1/4 DIN Horizontal PM4**

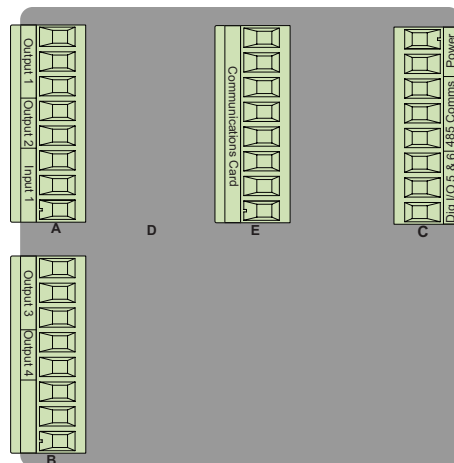

**EZ-ZONE PM Isolation Blocks.**

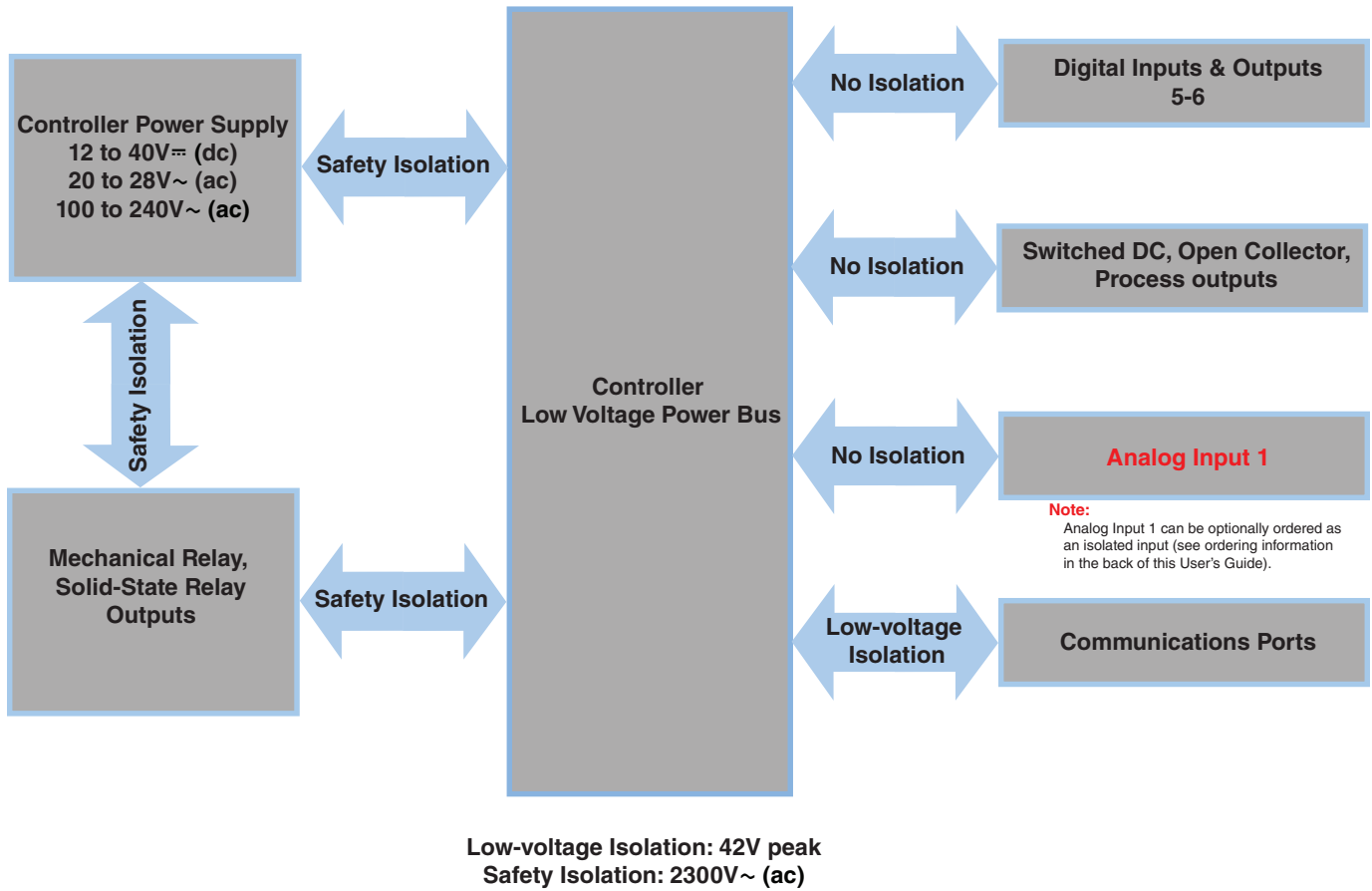



**Warning:**

Use National Electric (NEC) or other country-specific standard wiring and safety practices when wiring and connecting this controller to a power source and to electrical sensors or peripheral devices. Failure to do so may result in damage to equipment and property, and/or injury or loss of life.

**Note:**

Maximum wire size termination and torque rating:

- 0.0507 to 3.30 mm<sup>2</sup> (30 to 12 AWG) single-wire termination or two 1.31 mm<sup>2</sup> (16 AWG)
- 0.8 Nm (7.0 lb.-in.) torque

**Note:**

Adjacent terminals may be labeled differently, depending on the model number.

**Note:**

To prevent damage to the controller, do not connect wires to unused terminals.

**Note:**

Maintain electrical isolation between Analog Input 1, Digital I/O, Switched dc/open collector outputs and Process outputs to prevent ground loops.

**Note:**

The control output common terminal and the digital common terminal are referenced to different voltages and must remain isolated.

**Low Power**

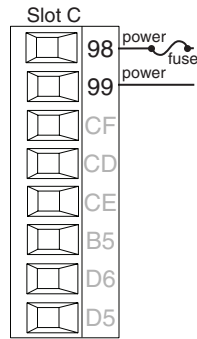

- Minimum/Maximum Ratings
  - 12 to 40V $\overline{=}$  (dc)
  - 20 to 28V $\sim$  (ac) Semi Sig F47
  - 47 to 63 Hz
  - 14VA maximum power consumption (PM4, 8 & 9)
  - 10VA maximum power consumption (PM3 & 6)
- PM\_ [3, 4] - - - - -

**High Power**

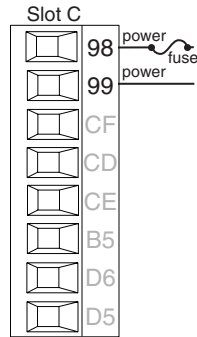

- Minimum/Maximum Ratings
  - 85 to 264V $\sim$  (ac)
  - 100 to 240V $\sim$  (ac) Semi Sig F47
  - 47 to 63 Hz
  - 14VA maximum power consumption (PM4, 8 & 9)
  - 10VA maximum power consumption (PM3 & 6)
- PM\_ [1, 2] - - - - -

**Digital Input 5, 6**

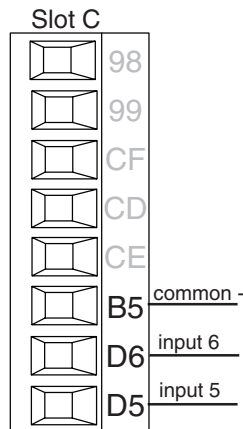

**Digital Input**

- Update rate 10 Hz
- Dry contact or dc voltage

**DC Voltage**

- Input not to exceed 36V at 3 mA
- Input active when > 3V @ 0.25 mA
- Input inactive when < 2V

**Dry Contact**

- Input inactive when > 500  $\Omega$
  - Input active when < 100  $\Omega$
  - maximum short circuit 13 mA
- PM\_ [2,4] - - - - -

**Voltage Input**

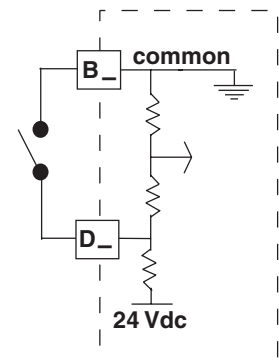
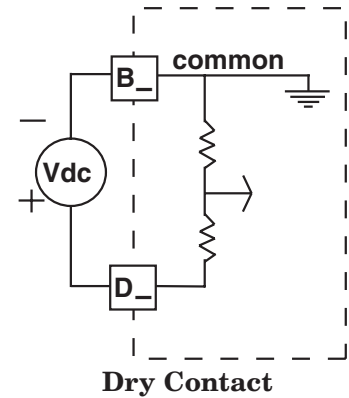



**Warning:**

Use National Electric (NEC) or other country-specific standard wiring and safety practices when wiring and connecting this controller to a power source and to electrical sensors or peripheral devices. Failure to do so may result in damage to equipment and property, and/or injury or loss of life.

**Note:**

Maximum wire size termination and torque rating:

- 0.0507 to 3.30 mm<sup>2</sup> (30 to 12 AWG) single-wire termination or two 1.31 mm<sup>2</sup> (16 AWG)
- 0.8 Nm (7.0 lb.-in.) torque

**Note:**

Adjacent terminals may be labeled differently, depending on the model number.

**Note:**

To prevent damage to the controller, do not connect wires to unused terminals.

**Note:**

Maintain electrical isolation between Analog Input 1, Digital I/O, Switched dc/open collector outputs and Process outputs to prevent ground loops.

**Note:**

The control output common terminal and the digital common terminal are referenced to different voltages and must remain isolated.

### Input 1 Thermocouple

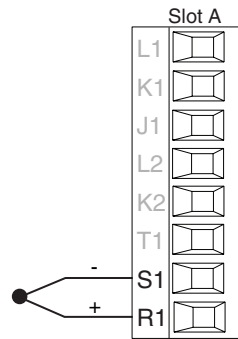

- 2K  $\Omega$  maximum source resistance
- >20 M $\Omega$  input impedance
- 3 microampere open-sensor detection
- Thermocouples are polarity sensitive. The negative lead (usually red) must be connected to S1.
- To reduce errors, the extension wire for thermocouples must be of the same alloy as the thermocouple.

Input 1: PM \_\_\_\_\_ (S1/R1)

### Input 1 RTD

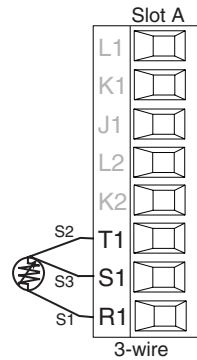
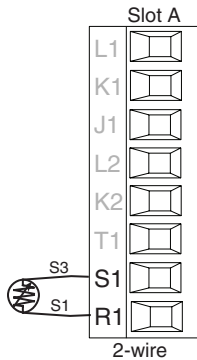

- platinum, 100 and 1,000  $\Omega$  @ 0°C
- calibration to DIN curve (0.00385  $\Omega/\Omega/^\circ\text{C}$ )
- 20  $\Omega$  total lead resistance
- RTD excitation current of 0.09 mA typical. Each ohm of lead resistance may affect the reading by 0.03°C.
- For 3-wire RTDs, the S1 lead (usually white) must be connected to R1.
- For best accuracy use a 3-wire RTD to compensate for lead-length resistance. All three lead wires must have the same resistance.

PM \_\_\_\_\_ AAA (all)

### Input 1 Process

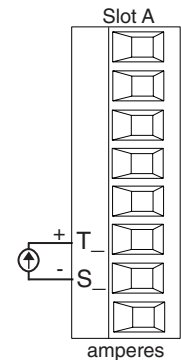
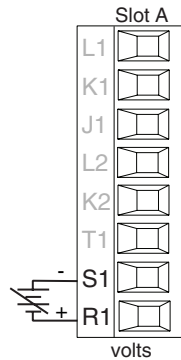

- 0 to 20 mA @ 100  $\Omega$  input impedance
- 0 to 10V $\approx$  (dc) @ 20 k $\Omega$  input impedance
- 0 to 50 mV $\approx$  (dc) @ 20 k $\Omega$  input impedance
- scalable

PM \_\_\_\_\_ AAA (all)

### Input 1 Potentiometer

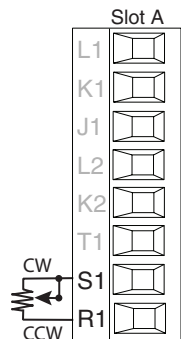

- Use a 1 k $\Omega$  potentiometer.

PM \_\_\_\_\_ AAA (all)



**Warning:**

Use National Electric (NEC) or other country-specific standard wiring and safety practices when wiring and connecting this controller to a power source and to electrical sensors or peripheral devices. Failure to do so may result in damage to equipment and property, and/or injury or loss of life.

**Note:**

Maximum wire size termination and torque rating:

- 0.0507 to 3.30 mm<sup>2</sup> (30 to 12 AWG) single-wire termination or two 1.31 mm<sup>2</sup> (16 AWG)
- 0.8 Nm (7.0 lb.-in.) torque

**Note:**

Adjacent terminals may be labeled differently, depending on the model number.

**Note:**

To prevent damage to the controller, do not connect wires to unused terminals.

**Note:**

Maintain electrical isolation between Analog Input 1, Digital I/O, Switched dc/open collector outputs and Process outputs to prevent ground loops.

**Note:**

The control output common terminal and the digital common terminal are referenced to different voltages and must remain isolated.

### Input 1 Thermistor

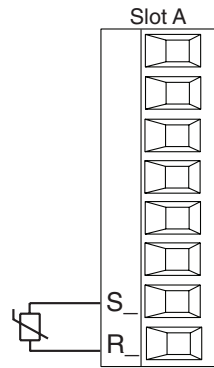

- >20 MΩ input impedance
  - 3 microampere open-sensor detection
- Input 1: PM \_ [M] \_ \_ \_ \_ \_ \_ \_ \_ \_ \_ (S1/R1)





**Warning:**

Use National Electric (NEC) or other country-specific standard wiring and safety practices when wiring and connecting this controller to a power source and to electrical sensors or peripheral devices. Failure to do so may result in damage to equipment and property, and/or injury or loss of life.

**Note:**

Maximum wire size termination and torque rating:

- 0.0507 to 3.30 mm<sup>2</sup> (30 to 12 AWG) single-wire termination or two 1.31 mm<sup>2</sup> (16 AWG)
- 0.8 Nm (7.0 lb.-in.) torque

**Note:**

Adjacent terminals may be labeled differently, depending on the model number.

**Note:**

To prevent damage to the controller, do not connect wires to unused terminals.

**Note:**

Maintain electrical isolation between Analog Input 1, Digital I/O, Switched dc/open collector outputs and Process outputs to prevent ground loops.

**Note:**

The control output common terminal and the digital common terminal are referenced to different voltages and must remain isolated.

**Quencharc Note:**

Switching pilot duty inductive loads (relay coils, solenoids, etc.) with the mechanical relay, solid state relay or open collector output options requires use of an R.C. suppressor.

### Digital Output 5, 6

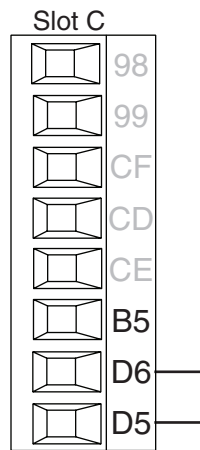

**Digital Output**

- Update rate 10 Hz
- Output voltage 24V
- Current limit, Output 5, 24 mA maximum
- Current limit, Output 6, 10 mA maximum driving single pole DIN-A-MITE
- \*Capable of driving a 3-pole DIN-A-MITE
- Open-circuit voltage 22 to 32V<sub>DC</sub>

PM \_ \_ [2, 4] \_ \_ \_ \_ \_

\* Output 5 only

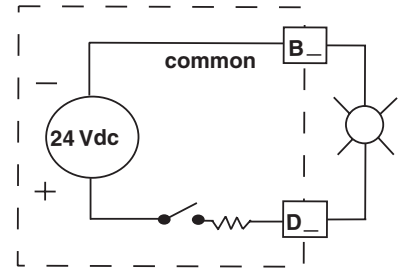

### Output 1 Switched DC/Open Collector

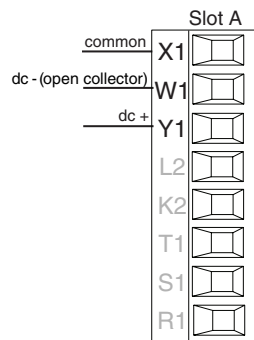

**Switched DC**

- 30 mA dc maximum supply current
- Short circuit limited to <50 mA
- 22 to 32V<sub>DC</sub> open circuit voltage
- Use dc- and dc+ to drive external solid-state relay.
- DIN-A-MITE compatible
- Single-pole: up to 4 in parallel or 4 in series
- 2-pole: up to 2 in parallel or 2 in series
- 3-pole: up to 2 in series

**Open Collector**

- 100 mA maximum output current sink
- 30V<sub>DC</sub> maximum supply voltage
- Any switched dc output can use the common terminal.
- Use an external power supply to control a dc load, with the load positive to the positive of the power supply, the load negative to the open collector and common to the power supply negative.

PM \_ \_ [C] \_ \_ \_ \_ AAA

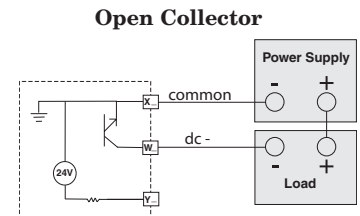
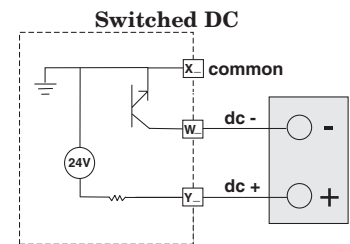

### Output 1 Mechanical Relay, Form C

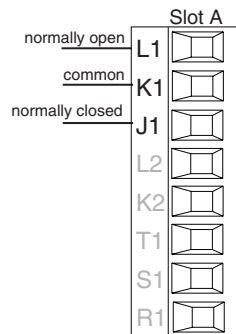

- 5 A at 240V<sub>AC</sub> or 30V<sub>DC</sub> maximum resistive load
  - 20 mA at 24V minimum load
  - 125 VA pilot duty at 120/240V<sub>AC</sub>, 25 VA at 24V<sub>AC</sub>
  - 100,000 cycles at rated load
  - Output does not supply power.
  - for use with ac or dc
- See Quencharc note.

PM \_ \_ [E] \_ \_ \_ \_ AAA

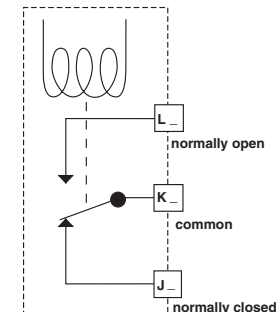

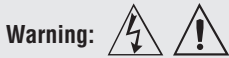

**Warning:**

Use National Electric (NEC) or other country-specific standard wiring and safety practices when wiring and connecting this controller to a power source and to electrical sensors or peripheral devices. Failure to do so may result in damage to equipment and property, and/or injury or loss of life.

**Note:**

- Maximum wire size termination and torque rating:
- 0.0507 to 3.30 mm<sup>2</sup> (30 to 12 AWG) single-wire termination or two 1.31 mm<sup>2</sup> (16 AWG)
  - 0.8 Nm (7.0 lb.-in.) torque

**Note:**

Adjacent terminals may be labeled differently, depending on the model number.

**Note:**

To prevent damage to the controller, do not connect wires to unused terminals.

**Note:**

Maintain electrical isolation between Analog Input 1, Digital I/O, Switched dc/open collector outputs and Process outputs to prevent ground loops.

**Note:**

The control output common terminal and the digital common terminal are referenced to different voltages and must remain isolated.

**Quencharc Note:**  
Switching pilot duty inductive loads (relay coils, solenoids, etc.) with the mechanical relay, solid state relay or open collector output options requires use of an R.C. suppressor.

### Output 2 Mechanical Relay, Form A

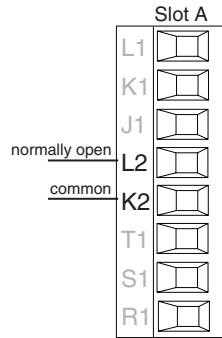

- 5 A at 240V~ (ac) or 30V<sup>≐</sup> (dc) maximum resistive load
  - 20 mA at 24V minimum load
  - 125 VA pilot duty @ 120/240V~ (ac), 25 VA at 24V~ (ac)
  - 100,000 cycles at rated load
  - Output does not supply power.
  - for use with ac or dc
- See Quencharc note.

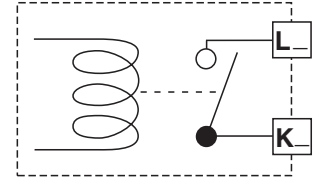

PM \_ \_ \_ [J] \_ \_ \_ AAA

### Output 3 Switched DC/Open Collector

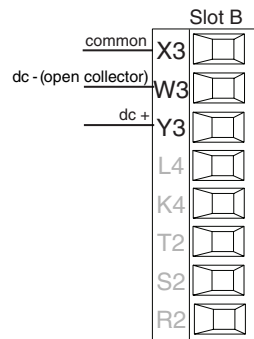

**Switched DC**

- 30 mA dc maximum supply current
- short circuit limited to <50 mA
- 22 to 32V<sup>≐</sup> (dc) open circuit voltage
- Use dc- and dc+ to drive external solid-state relay.
- DIN-A-MITE compatible
- Single-pole: up to 4 in parallel or 4 in series
- 2-pole: up to 2 in parallel or 2 in series
- 3-pole: up to 2 in series

**Open Collector**

- 100 mA maximum output current sink
- 30V<sup>≐</sup> (dc) maximum supply voltage
- Any switched dc output can use the common terminal.
- Use an external power supply to control a dc load, with the load positive to the positive of the power supply, the load negative to the open collector and common to the power supply negative.

See Quencharc note.

PM \_ \_ \_ \_ \_ [C] \_ AAA

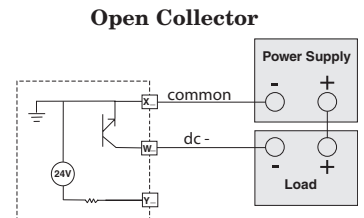
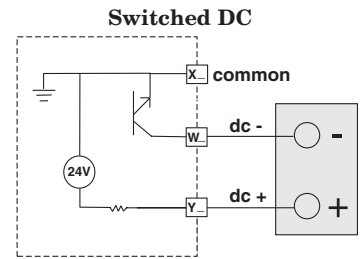

### Output 3 Mechanical Relay, Form C

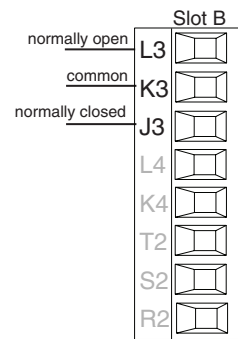

- 5 A at 240V~ (ac) or 30V<sup>≐</sup> (dc) maximum resistive load
  - 20 mA at 24V minimum load
  - 125 VA pilot duty at 120/240V~ (ac), 25 VA at 24V~ (ac)
  - 100,000 cycles at rated load
  - Output does not supply power.
  - for use with ac or dc
- See Quencharc note.

PM \_ \_ \_ \_ \_ [E] \_ AAA

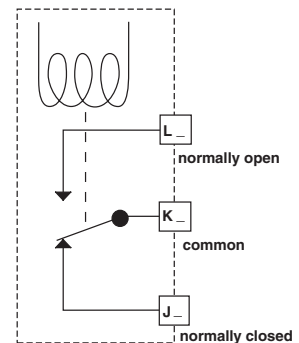



**Warning:**

Use National Electric (NEC) or other country-specific standard wiring and safety practices when wiring and connecting this controller to a power source and to electrical sensors or peripheral devices. Failure to do so may result in damage to equipment and property, and/or injury or loss of life.

**Note:**

Maximum wire size termination and torque rating:

- 0.0507 to 3.30 mm<sup>2</sup> (30 to 12 AWG) single-wire termination or two 1.31 mm<sup>2</sup> (16 AWG)
- 0.8 Nm (7.0 lb.-in.) torque

**Note:**

Adjacent terminals may be labeled differently, depending on the model number.

**Note:**

To prevent damage to the controller, do not connect wires to unused terminals.

**Note:**

Maintain electrical isolation between Analog Input 1, Digital I/O, Switched dc/open collector outputs and Process outputs to prevent ground loops.

**Note:**

The control output common terminal and the digital common terminal are referenced to different voltages and must remain isolated.

**Quencharc Note:**

Switching pilot duty inductive loads (relay coils, solenoids, etc.) with the mechanical relay, solid state relay or open collector output options requires use of an R.C. suppressor.

**Output 3 Universal Process**

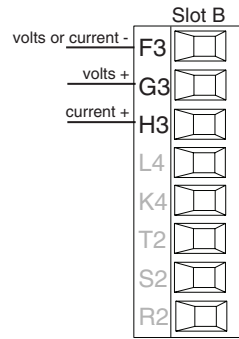

- 0 to 20 mA into 800 Ω maximum load
- 0 to 10V<sub>DC</sub> into 1 kΩ minimum load
- scalable
- output supplies power
- cannot use voltage and current outputs at same time
- Output may be used as retransmit or control.

PM \_ \_ \_ \_ \_ [F] \_ AAA

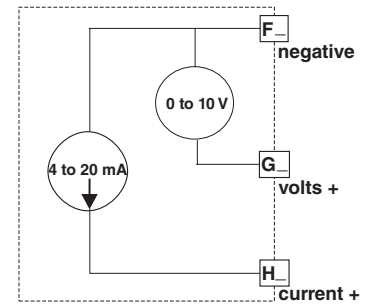

**Output 3 Solid-State Relay, Form A**

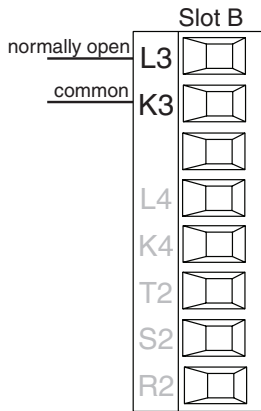

- 0.5 A at 20 to 264V~ (ac) maximum resistive load
- 20 VA 120/240V~ (ac) pilot duty
- opto-isolated, without contact suppression
- maximum off state leakage of 105 microamperes
- output does not supply power
- Do not use on dc loads.
- See Quencharc note.

PM \_ \_ \_ \_ \_ [K] \_ AAA

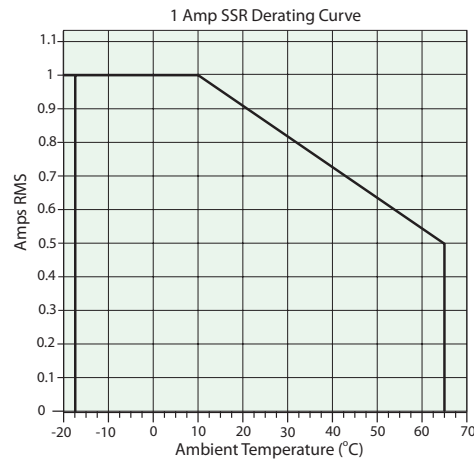
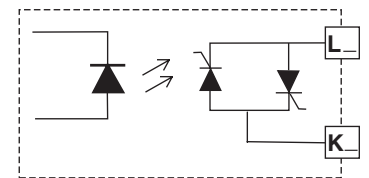

**Output 4 Switched DC**

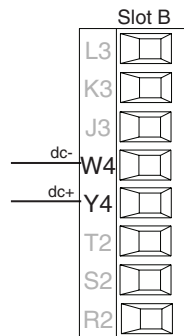

- 10 mA DC maximum supply current
- Short circuit limited to <50 mA
- 22 to 32V<sub>DC</sub> open circuit voltage
- Use dc- and dc+ to drive external solid-state relay.
- DIN-A-MITE compatible
- Single-pole: up to 2 in series, none in parallel

PM \_ \_ \_ \_ \_ [C] AAA

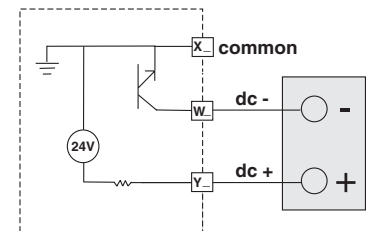



**Warning:**

Use National Electric (NEC) or other country-specific standard wiring and safety practices when wiring and connecting this controller to a power source and to electrical sensors or peripheral devices. Failure to do so may result in damage to equipment and property, and/or injury or loss of life.

**Note:**

- Maximum wire size termination and torque rating:
- 0.0507 to 3.30 mm<sup>2</sup> (30 to 12 AWG) single-wire termination or two 1.31 mm<sup>2</sup> (16 AWG)
  - 0.8 Nm (7.0 lb.-in.) torque

**Note:**

Adjacent terminals may be labeled differently, depending on the model number.

**Note:**

To prevent damage to the controller, do not connect wires to unused terminals.

**Note:**

Maintain electrical isolation between Analog Input 1, Digital I/O, Switched dc/open collector outputs and Process outputs to prevent ground loops.

**Note:**

The control output common terminal and the digital common terminal are referenced to different voltages and must remain isolated.

**Quencharc Note:**

Switching pilot duty inductive loads (relay coils, solenoids, etc.) with the mechanical relay, solid state relay or open collector output options requires use of an R.C. suppressor.

**Output 4 Mechanical Relay, Form A**

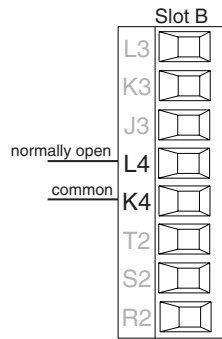

- 5 A at 240V~ (ac) or 30V= (dc) maximum resistive load
  - 20 mA at 24V minimum load
  - 125 VA pilot duty @ 120/240V~ (ac), 25 VA at 24V~ (ac)
  - 100,000 cycles at rated load
  - Output does not supply power.
  - for use with ac or dc
- See Quencharc note.  
PM \_\_\_\_\_ [J] AAA

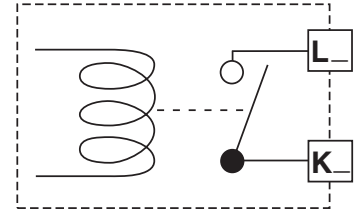

**Output 4 Solid-State Relay, Form A**

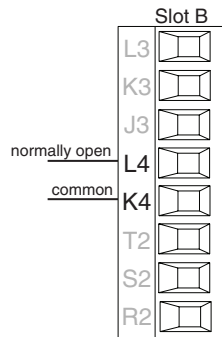

- 0.5 A at 20 to 264V~ (ac) maximum resistive load
  - 20 VA 120/240V~ (ac) pilot duty
  - opto-isolated, without contact suppression
  - maximum off state leakage of 105 microamperes
  - Output does not supply power.
  - Do not use on dc loads.
- See Quencharc note.  
PM \_\_\_\_\_ [K] AAA

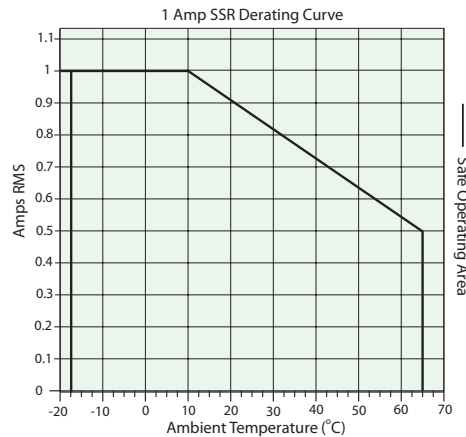
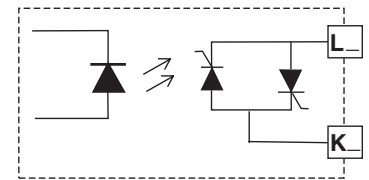

**Quencharc Wiring Example**

In this example the Quencharc circuit (Watlow part# 0804-0147-0000) is used to protect PM internal circuitry from the counter electromagnetic force from the inductive user load when de-energized. It is recommended that this or an equivalent Quencharc be used when connecting inductive loads to PM outputs.

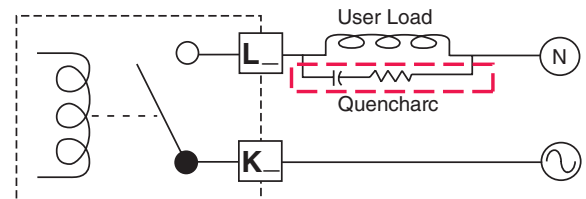



**Warning:**

Use National Electric (NEC) or other country-specific standard wiring and safety practices when wiring and connecting this controller to a power source and to electrical sensors or peripheral devices. Failure to do so may result in damage to equipment and property, and/or injury or loss of life.

**Note:**

Maximum wire size termination and torque rating:

- 0.0507 to 3.30 mm<sup>2</sup> (30 to 12 AWG) single-wire termination or two 1.31 mm<sup>2</sup> (16 AWG)
- 0.8 Nm (7.0 lb.-in.) torque

**Note:**

Adjacent terminals may be labeled differently, depending on the model number.

**Note:**

To prevent damage to the controller, do not connect wires to unused terminals.

**Note:**

Maintain electrical isolation between Analog Input 1, Digital I/O, Switched dc/open collector outputs and Process outputs to prevent ground loops.

**Note:**

The control output common terminal and the digital common terminal are referenced to different voltages and must remain isolated.

### Standard Bus EIA-485 Communications

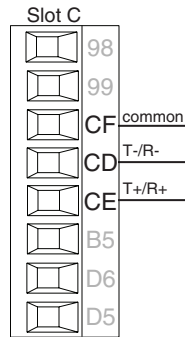

- Wire T-/R- to the A terminal of the EIA-485 port.
- Wire T+/R+ to the B terminal of the EIA-485 port.
- Wire common to the common terminal of the EIA-485 port.
- Do not route network wires with power wires. Connect network wires in daisy-chain fashion when connecting multiple devices in a network.
- Do not connect more than 16 EZ-ZONE PM controllers on a network.
- Maximum network length: 1,200 meters (4,000 feet)
- 1/8th unit load on EIA-485 bus  
PM \_\_\_\_\_-[A, 2 or 3] \_\_\_ AAA

**Note:**

Do not leave a USB to EIA-485 converter connected to Standard Bus without power (i.e., disconnecting the USB end from the computer while leaving the converter connected on Standard Bus). Disturbance on the Standard Bus may occur.

### Modbus RTU or Standard Bus EIA-485 Communications

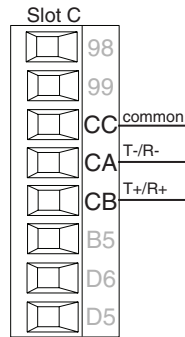

- Wire T-/R- to the A terminal of the EIA-485 port.
- Wire T+/R+ to the B terminal of the EIA-485 port.
- Wire common to the common terminal of the EIA-485 port.
- Do not route network wires with power wires. Connect network wires in daisy-chain fashion when connecting multiple devices in a network.
- A termination resistor may be required. Place a 120 Ω resistor across T+/R+ and T-/R- of last controller on network.
- Only one protocol per port is available at a time: either Modbus RTU or Standard Bus.
- Do not connect more than 16 EZ-ZONE PM controllers on a Standard Bus network.
- Maximum number of EZ-ZONE controllers on a Modbus RTU network is 247.
- Maximum network length: 1,200 meters (4,000 feet)
- 1/8th unit load on EIA-485 bus  
PM \_\_\_\_\_-[1] \_\_\_ AAA

**Note:**

Do not leave a USB to EIA-485 converter connected to Standard Bus without power (i.e., disconnecting the USB end from the computer while leaving the converter connected on Standard Bus). Disturbance on the Standard Bus may occur.



**Warning:**

Use National Electric (NEC) or other country-specific standard wiring and safety practices when wiring and connecting this controller to a power source and to electrical sensors or peripheral devices. Failure to do so may result in damage to equipment and property, and/or injury or loss of life.

**Note:**

Maximum wire size termination and torque rating:

- 0.0507 to 3.30 mm<sup>2</sup> (30 to 12 AWG) single-wire termination or two 1.31 mm<sup>2</sup> (16 AWG)
- 0.8 Nm (7.0 lb.-in.) torque

**Note:**

Adjacent terminals may be labeled differently, depending on the model number.

**Note:**

To prevent damage to the controller, do not connect wires to unused terminals.

**Note:**

Maintain electrical isolation between Analog Input 1, Digital I/O, Switched dc/open collector outputs and Process outputs to prevent ground loops.

**Note:**

The control output common terminal and the digital common terminal are referenced to different voltages and must remain isolated.

## EIA-232/485 Modbus RTU Communications

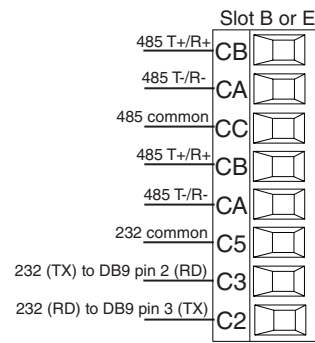

- Wire T-/R- to the A terminal of the EIA-485 port.
- Wire T+/R+ to the B terminal of the EIA-485 port.
- Wire common to the common terminal of the EIA-485 port.
- Do not route network wires with power wires. Connect network wires in daisy-chain fashion when connecting multiple devices in a network.
- A termination resistor may be required. Place a 120 Ω resistor across T+/R+ and T-/R- of last controller on network.
- Do not wire to both the EIA-485 and the EIA-232 pins at the same time.
- Two EIA-485 terminals of T/R are provided to assist in daisy-chain wiring.
- Do not connect more than one EZ-ZONE PM controller on an EIA-232 network.
- Do not connect more than 16 EZ-ZONE PM controllers on a Standard Bus EIA-485 network.
- Do not connect more than 247 EZ-ZONE PM controllers on a Modbus RTU EIA-485 network.
- maximum EIA-232 network length: 15 meters (50 feet)
- maximum EIA-485 network length: 1,200 meters (4,000 feet)
- 1/8th unit load on EIA-485 bus.

PM [4, 6, 8, 9] \_ \_ \_ \_-[2] AAA AAA

Modbus-IDA Terminal	EIA/TIA-485 Name	Watlow Terminal Label	Function
DO	A	CA or CD	T-/R-
D1	B	CB or CE	T+/R+
common	common	CC or CF	common

## EtherNet/IP™ and Modbus TCP Communications

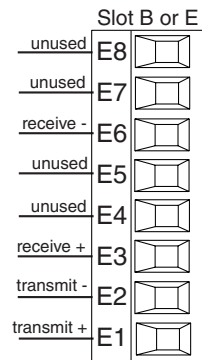

RJ-45 pin	T568B wire color	Signal	Slot B or E
8	brown	unused	E8
7	brown & white	unused	E7
6	green	receive -	E6
5	white & blue	unused	E5
4	blue	unused	E4
3	white & green	receive +	E3
2	orange	transmit -	E2
1	white & orange	transmit +	E1

EtherNet/IP™ and Modbus TCP communications to connect with a 10/100 switch.

- Do not route network wires with power wires.
- Connect one Ethernet cable per controller to a 10/100 mbps ethernet switch. Both Modbus TCP and EtherNet/IP™ are available on the network.
- An RUI may be connected at the same time using Slot C. PM [4, 6, 8, 9] \_ \_ \_ \_-[3] \_ \_ \_ AAA

**Note:**

When changing the fixed IP address cycle module power for new address to take effect

### Ethernet LED Indicators

Viewing the control from the front and then looking on top four LEDs can be seen aligned vertically front to back. The LEDs are identified accordingly: closest to the front reflects the Network (Net) Status, Module (Mod) Status is next, Activity status follows and lastly, the LED closest to the rear of the control reflects the Link status.

**Note:**

When using Modbus TCP, the Network Status and Module Status LEDs are not used.



Use National Electric (NEC) or other country-specific standard wiring and safety practices when wiring and connecting this controller to a power source and to electrical sensors or peripheral devices. Failure to do so may result in damage to equipment and property, and/or injury or loss of life.

**Note:**

Maximum wire size termination and torque rating:

- 0.0507 to 3.30 mm<sup>2</sup> (30 to 12 AWG) single-wire termination or two 1.31 mm<sup>2</sup> (16 AWG)
- 0.8 Nm (7.0 lb.-in.) torque

**Note:**

Adjacent terminals may be labeled differently, depending on the model number.

**Note:**

To prevent damage to the controller, do not connect wires to unused terminals.

**Note:**

Maintain electrical isolation between Analog Input 1, Digital I/O, Switched dc/open collector outputs and Process outputs to prevent ground loops.

**Note:**

The control output common terminal and the digital common terminal are referenced to different voltages and must remain isolated.

**Network Status**

Indicator State	Summary	Requirement
Steady Off	Not powered, no IP address	If the device does not have an IP address (or is powered off), the network status indicator shall be steady off.
Flashing Green	No connections	If the device has no established connections, but has obtained an IP address, the network status indicator shall be flashing green.
Steady Green	Connected	If the device has at least one established connection (even to the Message Router), the network status indicator shall be steady green.
Flashing Red	Connection timeout	If one or more of the connections in which this device is the target has timed out, the network status indicator shall be flashing red. This shall be left only if all timed out connections are reestablished or if the device is reset.
Steady Red	Duplicate IP	If the device has detected that its IP address is already in use, the network status indicator shall be steady red.
Flashing Green / Red	Self-test	While the device is performing its power up testing, the network status indicator shall be flashing green / red.

**Module Status**

Indicator State	Summary	Requirement
Steady Off	No power	If no power is supplied to the device, the module status indicator shall be steady off.
Steady Green	Device operational	If the device is operating correctly, the module status indicator shall be steady green.
Flashing Green	Standby	If the device has not been configured, the module status indicator shall be flashing green.
Flashing Red	Minor fault	If the device has detected a recoverable minor fault, the module status indicator shall be flashing red. NOTE: An incorrect or inconsistent configuration would be considered a minor fault.
Steady Red	Major fault	If the device has detected a non-recoverable major fault, the module status indicator shall be steady red.
Flashing Green / Red	Self-test	While the device is performing its power up testing, the module status indicator shall be flashing green / red.

**Link Status**

Indicator State	Summary	Requirement
Steady Off	Not powered, unknown link speed	If the device cannot determine link speed or power is off, the network status indicator shall be steady off.
Green	----	If cable is wired and connected correctly, the LED will be Green.



**Warning:**

Use National Electric (NEC) or other country-specific standard wiring and safety practices when wiring and connecting this controller to a power source and to electrical sensors or peripheral devices. Failure to do so may result in damage to equipment and property, and/or injury or loss of life.

**Note:**

Maximum wire size termination and torque rating:

- 0.0507 to 3.30 mm<sup>2</sup> (30 to 12 AWG) single-wire termination or two 1.31 mm<sup>2</sup> (16 AWG)
- 0.8 Nm (7.0 lb.-in.) torque

**Note:**

Adjacent terminals may be labeled differently, depending on the model number.

**Note:**

To prevent damage to the controller, do not connect wires to unused terminals.

**Note:**

Maintain electrical isolation between Analog Input 1, Digital I/O, Switched dc/open collector outputs and Process outputs to prevent ground loops.

**Note:**

The control output common terminal and the digital common terminal are referenced to different voltages and must remain isolated.

**Activity Status**

Indicator State	Summary	Requirement
Flashing Green	Detects activity	If the MAC detects activity, the LED will be flashing green.
Red	----	If the MAC detects a collision, the LED will be red.

**DeviceNet™ Communications**

Slot B or E		Terminal	Signal	Function
V+	V+	V+	V+	DeviceNet™ power
CAN_H	CH	CH	CAN_H	positive side of DeviceNet™ bus
shield	SH	SH	shield	shield interconnect
CAN_L	CL	CL	CAN_L	negative side of DeviceNet™ bus
V-	V-	V-	V-	DeviceNet™ power return

PM [4, 6, 8, 9] ---- - [5] -----

**DeviceNet LED Indicators**

Viewing the control from the front and then looking on top two LEDs can be seen aligned vertically front to back. The LED closest to the front is identified as the network (Net) LED where the one next to it would be identified as the module (Mod) LED.

**Network Status**

Indicator LED	Description
Off	The device is not online and has not completed the duplicate MAC ID test yet. The device may not be powered.
Green	The device is online and has connections in the established state (allcated to a Master).
Red	Failed communication device. The device has detected an error that has rendered it incapable of communicating on the network (duplicate MAC ID or Bus-off).
Flashing Green	The device is online, but no connection has been allocated or an explicit connection has timed out.
Flashing Red	A poll connection has timed out.

**Module Status**

Indicator LED	Description
Off	No power is applied to the device.
Flashing Green-Red	The device is performing a self-test.
Flashing Red	Major Recoverable Fault.
Red	Major Unrecoverable Fault.
Green	The device is operating normally.





**Warning:**

Use National Electric (NEC) or other country-specific standard wiring and safety practices when wiring and connecting this controller to a power source and to electrical sensors or peripheral devices. Failure to do so may result in damage to equipment and property, and/or injury or loss of life.

**Note:**

Maximum wire size termination and torque rating:

- 0.0507 to 3.30 mm<sup>2</sup> (30 to 12 AWG) single-wire termination or two 1.31 mm<sup>2</sup> (16 AWG)
- 0.8 Nm (7.0 lb.-in.) torque

**Note:**

Adjacent terminals may be labeled differently, depending on the model number.

**Note:**

To prevent damage to the controller, do not connect wires to unused terminals.

**Note:**

Maintain electrical isolation between Analog Input 1, Digital I/O, Switched dc/open collector outputs and Process outputs to prevent ground loops.

**Note:**

The control output common terminal and the digital common terminal are referenced to different voltages and must remain isolated.

## Profibus DP Communications

	Slot B & E		
+5Vdc Voltage Potential	VP		<ul style="list-style-type: none"> <li>• Wire T-/R- to the A terminal of the EIA-485 port.</li> <li>• Wire T+/R+ to the B terminal of the EIA-485 port.</li> <li>• Wire Digital Ground to the common terminal of the EIA-485 port.</li> <li>• Do not route network wires with power wires. Connect network wires in daisy-chain fashion when connecting multiple devices in a network.</li> <li>• A termination resistor should be used if this control is the last one on the network.</li> <li>• If using a 150 Ω cable Watlow provides internal termination. Place a jumper across pins trB and B and trA and A.</li> <li>• If external termination is to be used with a 150 Ω cable place a 390 Ω re-sistor across pins VP and B, a 220 Ω resistor across pins B and A, and lastly, place a 390 Ω resistor across pins DG and A.</li> <li>• Do not connect more than 32 EZ-ZONE PM controllers on any given segment.</li> <li>• Maximum EIA-485 network length: 1,200 meters (4,000 feet)</li> <li>• 1/8th unit load on EIA-485 bus. PM [4, 6, 8, 9] _ _ _ _-[6] AAA AAA</li> </ul>
485 T+/R+	B		
485 T-/R-	A		
Digital ground	DG		
Termination resistor B	trB		
485 T+/R+	B		
485 T-/R-	A		
Termination resistor A	trA		

Profibus Terminal	EIA/TIA-485 Name	Watlow Terminal Label	Function
VP (Voltage Potential)	---	VP	+5Vdc
B-Line	B	B	T+/R+
A-Line	A	A	T-/R-
DP-GND	common	DG	common

### Profibus DP LED Indicators

Viewing the unit from the front and then looking on top of the RUI/GTW two bi-color LEDs can be seen where only the front one is used. Definition follows:

#### Closest to the Front

Indicator LED	Description
Red	Profibus network not detected
Red Flashing	Indicates that the Profibus card is waiting for data exchange.
Green	Data exchange mode



**Warning:**

Use National Electric (NEC) or other country-specific standard wiring and safety practices when wiring and connecting this controller to a power source and to electrical sensors or peripheral devices. Failure to do so may result in damage to equipment and property, and/or injury or loss of life.

**Note:**

Maximum wire size termination and torque rating:

- 0.0507 to 3.30 mm<sup>2</sup> (30 to 12 AWG) single-wire termination or two 1.31 mm<sup>2</sup> (16 AWG)
- 0.8 Nm (7.0 lb.-in.) torque

**Note:**

Adjacent terminals may be labeled differently, depending on the model number.

**Note:**

To prevent damage to the controller, do not connect wires to unused terminals.

**Note:**

Maintain electrical isolation between Analog Input 1, Digital I/O, Switched dc/open collector outputs and Process outputs to prevent ground loops.

**Note:**

The control output common terminal and the digital common terminal are referenced to different voltages and must remain isolated.

## Wiring a Serial EIA-485 Network

Do not route network wires with power wires. Connect network wires in daisy-chain fashion when connecting multiple devices in a network.

A termination resistor may be re-

quired. Place a 120 Ω resistor across T+/R+ and T-/R- of the last controller on a network.

Only one protocol per port is available at a time: either Modbus RTU or Standard Bus.

### A network using Watlow's Standard Bus and an RUI/Gateway.

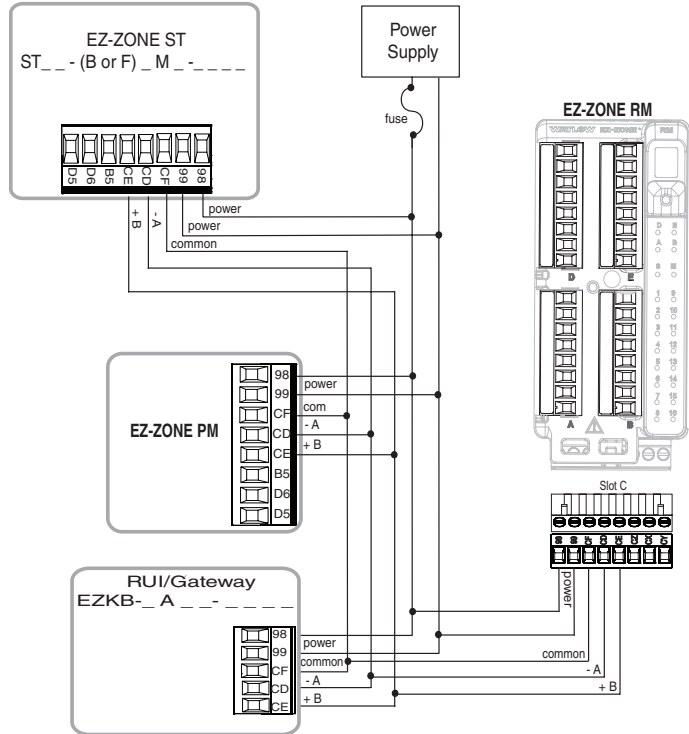

### A network with all devices configured using Modbus RTU.

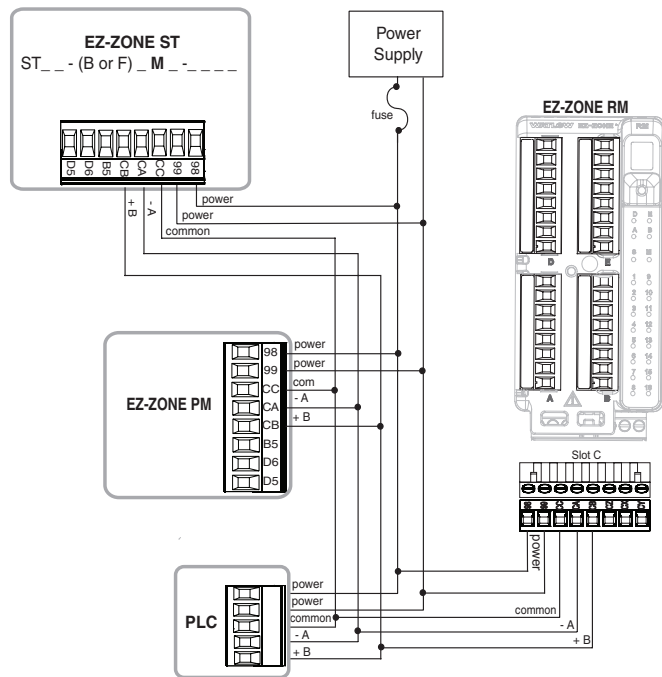



**Warning:** Use National Electric (NEC) or other country-specific standard wiring and safety practices when wiring and connecting this controller to a power source and to electrical sensors or peripheral devices. Failure to do so may result in damage to equipment and property, and/or injury or loss of life.

**Note:** Maximum wire size termination and torque rating:  
 • 0.0507 to 3.30 mm<sup>2</sup> (30 to 12 AWG) single-wire termination or two 1.31 mm<sup>2</sup> (16 AWG)  
 • 0.8 Nm (7.0 lb.-in.) torque

**Note:** Adjacent terminals may be labeled differently, depending on the model number.

**Note:** To prevent damage to the controller, do not connect wires to unused terminals.

**Note:** Maintain electrical isolation between Analog Input 1, Digital I/O, Switched dc/open collector outputs and Process outputs to prevent ground loops.

**Note:** The control output common terminal and the digital common terminal are referenced to different voltages and must remain isolated.

## Connecting a Computer to PM Controls Using B&B 485 to USB Converter

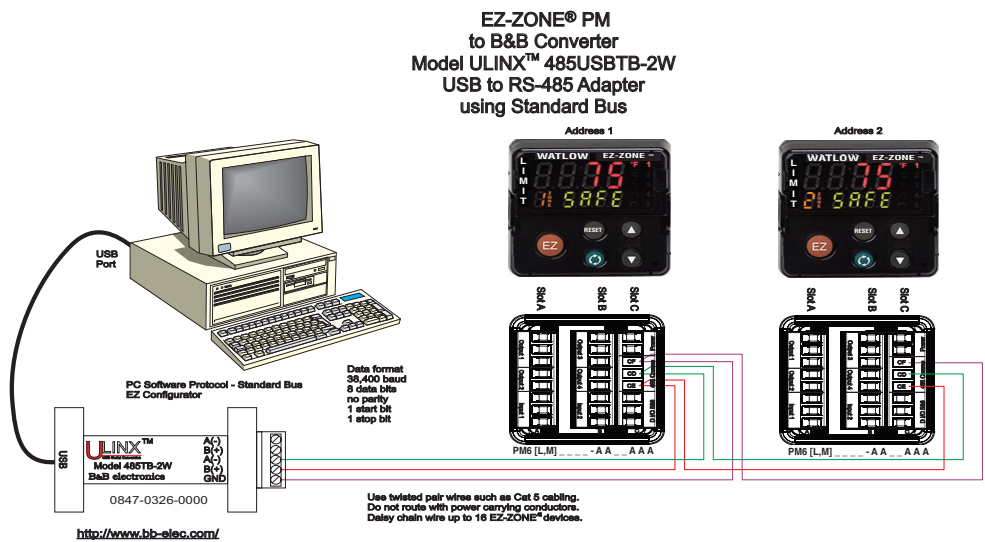

**Note:** Do not leave a USB to EIA-485 converter connected to Standard Bus without power (i.e., disconnecting the USB end from the computer while leaving the converter connected on Standard Bus). Disturbance on the Standard Bus may occur.

**Note:** When connecting the USB converter to the PC it is suggested that the Latency Timer be changed from the default of 16 msec to 1 msec. Failure to make this change may cause communication loss between the PC running EZ-ZONE Configurator software and the control.

To modify Latency Timer settings follow the steps below:

1. Navigate to Device Manager.
2. Double click on Ports.
3. Right click on the USB serial port in use and select Properties.
4. Click the tab labeled Port settings and then click the Advance button.

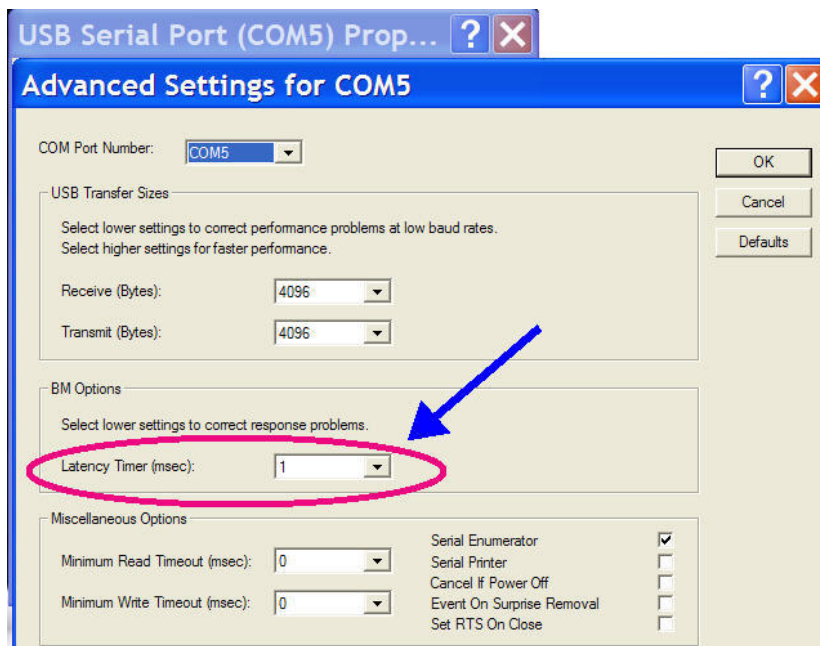

# 3

## Chapter 3: Keys and Displays

### Upper (Left, 32<sup>nd</sup> DIN) Display:

In the Home Page, displays the process value, otherwise displays the value of the parameter in the display.

### Zone Display:

Indicates the controller zone.

1 to 9 = zones 1 to 9

A = zone 10      E = zone 14

b = zone 11      F = zone 15

C = zone 12      h = zone 16

d = zone 13

### Percent Units:

Lights when the controller is displaying values as a percentage

### Channel Display:

Indicates the channel for any given EZ-ZONE module.

- Available with the PM4, 8 and PM9 only.

### Reset Key

Press to back up one level, or press and hold for two seconds to return to the Home Page. From the Home Page will reset the limit and clear alarms and errors if clearable.

### Advance Key

Advances through parameter prompts.

### 1/32 DIN (PM3)



### Lower (Right, 32<sup>nd</sup> DIN) Display:

Indicates the set point or output power value during operation, or the parameter whose value appears in the upper display.

### 1/16 DIN (PM6)



### EZ Key/s:

This key can be programmed to do various tasks, such as locking the keyboard, restoring user settings, etc...

### 1/8 DIN (PM9) Horizontal

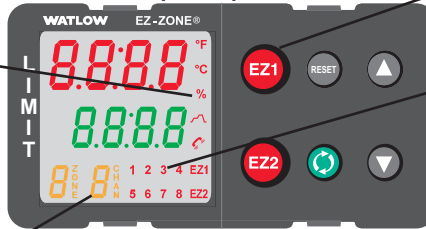

### Output Activity:

Number LEDs indicate activity of outputs. A flashing light indicates output activity.

### 1/8 DIN (PM8) Vertical

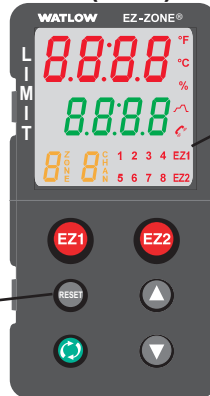

### Communications Activity

Flashes when another device is communicating with this controller.

### Temperature Units:

Indicates whether the temperature is displayed in Fahrenheit or Celsius.

### 1/4 DIN (PM4)

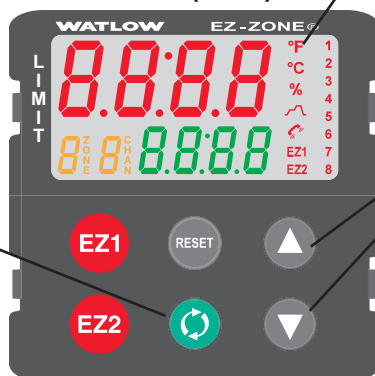

### Up and Down Keys

In the Home Page, adjusts the set point in the lower display. In other pages, changes the upper display to a higher or lower value, or changes a parameter selection.

### Note:

Upon power up, the upper or left display will briefly indicate the firmware revision and the lower or right display will show PM representing the model.

## Responding to a Displayed Messages

An active message will cause the display to toggle between the normal settings and the active message in the upper display and **Attn** in the lower display.

Your response will depend on the message and the controller settings. If the message was generated by a latched alarm or limit condition, the message can be cleared when the condition no longer exists by simply pushing the Reset **⏏** key or alternatively by following the steps below.

Push the Advance Key to display **999** in the upper display and the message source (such as **Lh1**) in the lower display.

Use the Up **▲** or Down **▼** keys to scroll through possible responses, such as Clear **CLR** or Silence **SIL**. Then push the Advance **⏏** or Reset **⏏** key to execute the action.

## Attention Codes

Display	Parameter Name Description	Setting	Range	De- fault	Appears If
<b>Attn</b>	<p><b>Attention</b></p> <p>An active message will cause the display to toggle between the normal settings and the active message in the upper display and <b>Attn</b> in the lower display.</p> <p>Your response will depend on the message and the controller settings. If the message was generated by a latched alarm or limit condition, the message can be cleared when the condition no longer exists. As with the above conditions if an alarm has silencing enabled, it can be silenced by simply pushing the Reset <b>⏏</b> Key or alternatively by following the steps below.</p> <p>Push the Advance key to display <b>999</b> in the upper display and the message source (such as <b>Lh1</b>) in the lower display.</p> <p>Use the Up <b>▲</b> or Down <b>▼</b> keys to scroll through possible responses, such as Clear <b>CLR</b> or Silence <b>SIL</b>. Then push the Advance <b>⏏</b> or Reset <b>⏏</b> key to execute the action.</p>		<p><b>ALL1 ALL2 ALL3 ALL4</b> Alarm Low 1 to 4</p> <p><b>ALH1 ALH2 ALH3 ALH4</b> Alarm High 1 to 4</p> <p><b>ALE1 ALE2 ALE3 ALE4</b> Alarm Error 1 to 4</p> <p><b>Er.1</b> Error Input 1</p> <p><b>L.L1</b> Limit Low 1</p> <p><b>L.H1</b> Limit High 1</p> <p><b>L.E1</b> Limit Error 1</p> <p><b>uALH</b> Value to high to be displayed in 4 digit LED display &gt;9999</p> <p><b>uALL</b> Value to low to be displayed in 4 digit LED display &lt;-1999</p>		an alarm or error message is active.

### Parameters that appear only in the Home Page

# 4

## Chapter 4: Home Page

### Default Home Page Parameters

Watlow's patented user-defined menu system improves operational efficiency. The user-defined Home Page provides you with a shortcut to monitor or change the parameter values that you use most often. The default Home Page is shown on the following page. When a parameter normally located in the Setup Page or Operations Page is placed in the Home Page, it is accessible through both. If you change a parameter in the Home Page, it is automatically changed in its original page. If you change a parameter in its original page it is automatically changed in the Home Page.

The Attention **ATTN** parameter appears only if there is an active message. An example of an active message could be that Alarm 1 High occurred where the display would flash **ATTN** on the bottom display and **ALH1** on top.

Use the Advance key **⏩** to step through the other parameters. When not in pairs the parameter prompt will appear in the lower display, and the parameter value will appear in the upper display. You can use the Up **⬆** or Down **⬇** keys to change the value of writable parameters, just as you would in any other menu.

If a sensor failure has occurred, dashed lines **----** will appear in the upper display and **FRIL** in the lower display. This would also cause the limit to trip as well.

### Changing the Set Point

From the default Home Page the Limit set points (high and or low) can be changed. If the Limit is set up for high and low limits push the Advance **⏩** key one time and the Limit Low Set Point **LLS1** prompt will appear in the lower display while the current set point will be displayed above. Pushing the Up **⬆** or Down **⬇** keys will change the set point. Once done, simply push the Advance **⏩** key to display the Limit High Set Point **LHS1** will appear below and the current high set point will be displayed above. Again, to change simply push the Up and Down arrow keys.

### Modifying the Home Page

Follow the steps below to modify the Home Page:

1. Push and hold the Advance **⏩** key and the Infinity **∞** key for approximately six seconds.  
Upon entering the Factory Page the first menu will be the Custom Menu **CUSE**.
2. Push the Advance **⏩** key where the lower display will show **CUSE** and the upper display will show **1**.
3. Push the Advance **⏩** button where the prompt for the Process Value **RCPU** will be displayed on top and Parameter **PRR** in the bottom.

There are twenty positions available that can be customized.

4. Pushing the Up **⬆** or Down **⬇** arrow keys will allow for a customized selection to be made (see list of available parameters below).

Custom Menu Parameter Options	
Description	Prompt *
All Models	
None	Blank
Analog Input Value	<b>AIN1</b>
Cal In Offset	<b>ICAI</b>
Display Units	<b>CF1</b>
Load Parameter Set	<b>USR.1 USR.2</b>
Alarm Low Set Point	<b>ALo1 ALo2 ALo3 ALo4</b>
Alarm High Set Point	<b>Ah1 Ah2 Ah3 Ah4</b>
Alarm Hysteresis	<b>AhY1 AhY2 AhY3 AhY4</b>
Limit Low Set Point	<b>LLS1</b>

Custom Menu Parameter Options	
Description	Prompt *
Limit High Set Point	<b>Lh.S I</b>
Limit Hysteresis	<b>Lh.Y I</b>
Limit Status	<b>LSt I</b>

\* The numerical digit shown in the prompts above (last digit), represents the parameter instance and can be greater than one.

## Modifying the Display Pairs

The Home Page, being a customized list of as many as 20 parameters can be configured in pairs of up to 10 via the Display Pairs **dPrS** prompt.

### Note:

For firmware release 11.0 and above the Display Pairs prompt can be found in the Setup Page under the Global Menu **GLbL**.

For firmware releases below revision 11.0 this prompt can be found in the Factory Page under the Diagnostic Menu **d,rg**.

The listing in the table that follows represents the Limit default Home Page. It is important to note that some of the prompts shown may not appear simply because the feature is not being used or is turned off. As an example, the prompt shown in position 3 (Limit Low Set Point) will not appear unless the Limit Sides **L.Sd** is set up for Both (high and low) or low in the Setup Page under the Limit Menu.

Home Page Default Parameters			
Custom Menu Number	Home Page Display (defaults)	Parameter Name	Custom Menu Display (defaults)
1 (Upper or left display)	Numerical value	Active Process Value	<b>Rin I</b> Firmware revision 11.0 and above <b>Pro</b> Firmware below revision 11.0
2 (Lower or right display)	<b>SAFE</b> or <b>FRIL</b>	Limit Status	<b>LSt</b>
3	Numerical value	Limit Low Set Point	<b>LLS I</b>
4	Numerical value	Limit High Set Point	<b>LhS I</b>
5 to 20	(skipped)		<b>nonE</b>

### Note:

When the Limit is in a default state (as shipped from factory), the display will flash where the top display will show the Process Value and **L.h I**, and the bottom will display **RtLn** and **FRIL**.

As stated above, the user can define ten pairs of prompts to appear on the display every time the Advance **Ⓢ** key is pushed. In a default state the Display Pairs **dPrS** prompt is equal to one with the first pair displayed as is defined in the Home Page table above. If the Display Pairs prompt were to be changed to two, pushing the Advance key one time would cause the display to show the Limit Low Set Point on the top and the Limit High Set point on the bottom reflecting position 3 and 4 respectively.

### Note:

Both of these parameters are writable and being paired in this manner only the Limit High Set Point can be changed. Pairing two writable prompts will only allow for the bottom one to be changed. On the other hand, if a writable value is placed on the upper display and is paired with another read only parameter on the lower display, the arrow keys affect the setting of the upper display.

The display can be configured to scroll through the Display Pairs by going to the Setup Page under the Global Menu and changing the Display Time **d.t I** prompt to something greater than 0. If set to 2, the display will scroll through the pairs every 2 seconds starting with Custom Menu Pair 1 and 2, 3 and 4, etc...

## Navigating the EZ-ZONE PM Limit Controller PM6 Shown, Applies to All Models

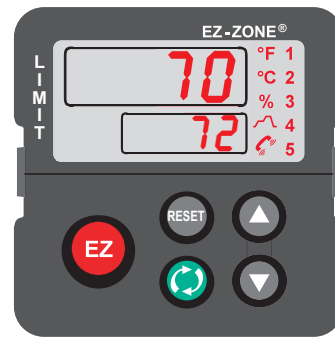

**Home Page from anywhere:** Press the Reset  key for two seconds to return to the Home Page.

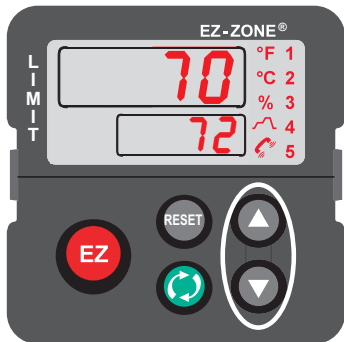

---



**Operations Page from Home Page:** Press both the Up  and Down  keys for three seconds.

---



**Setup Page from Home Page:** Press both the Up  and Down  keys for six seconds.

### Note:

Keys must be held continuously until SEt is displayed in green. If keys are released when OPER is displayed, press the infinity key or reset key to exit and repeat until SEt is displayed.

---

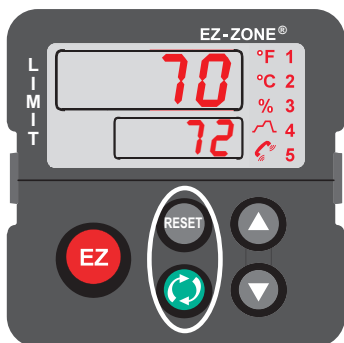

**Factory Page from Home Page:** Press both the Advance  and Reset  keys for six seconds..

---















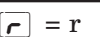



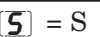



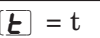



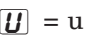



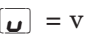



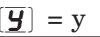

## Conventions Used in the Menu Pages

To better understand the menu pages that follow review the naming conventions used. When encountered throughout this document, the word "default" implies as shipped from the factory. Each page (Operations, Setup, Profile and Factory) and their associated menus have identical headers defined below:

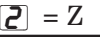

Header Name	Definition
Display	Visually displayed information from the control.
Parameter Name	Describes the function of the given parameter.
Range	Defines options available for this prompt, i.e., min/max values (numerical), yes/no, etc... (further explanation below).
Default	Values as delivered from the factory.
Parameter Appears in Menu When	Conditions required for parameter to appear in menu.
Modbus Relative Address	Identifies unique parameters using either the Modbus RTU or Modbus TCP protocols (further explanation below).
CIP (Common Industrial Protocol)	Identifies unique parameters using either the DeviceNet or Ethernet/IP protocol (further explanation below).
Profibus Index	Identifies unique parameters using Profibus DP protocol (further explanation below).
Parameter ID	Identifies unique parameters used with other software such as, LabVIEW.
Data Type R/W	uint = Unsigned 16 bit integer dint = long, 32-bit string = ASCII (8 bits per character) float = IEEE 754 32-bit RWES = <b>R</b> eadable <b>W</b> ritable <b>E</b> EPR <b>O</b> M (saved) <b>U</b> ser <b>S</b> et (saved)

### Display

Visual information from the control is displayed to the observer using a fairly standard 7 segment display. Due to the use of this technology, several characters displayed need some interpretation, see the list below:

 = 1	 = 0	 = i	 = r
 = 2	 = A	 = J	 = S
 = 3	 = b	 = K	 = t
 = 4	 = c	 = L	 = u
 = 5	 = d	 = M	 = v
 = 6	 = E	 = n	 = W
 = 7	 = F	 = o	 = y
 = 8	 = g	 = P	 = Z
 = 9	 = h	 = q	

### Range

Within this column notice that on occasion there will be numbers found within parenthesis. This number represents the enumerated value for that particular selection. Range selections can be made simply by writing the enumerated value of choice using any of the available communications protocols. As an example, turn to the Setup Page and look at the Analog Input  menu and then the Sensor Type  prompt. To turn the sensor off simply write the value of 62 (off) to Modbus register 400369 and send that value to the control.

## Communication Protocols

When using a communications protocol in conjunction with the EZ-ZONE PML there may be two possible ports (instances) used. Port 1 or instance 1 is always dedicated to Standard Bus communications. This same instance can also be used for Modbus RTU if ordered. Depending on the controller part number port 2 (instance 2) can be used with Modbus, CIP and Profibus. For further information read through the remainder of this section.

---

### Modbus RTU & TCP Protocols

All Modbus registers are 16-bits and as displayed in this manual are relative addresses (actual). Some legacy software packages limit available Modbus registers to 40001 to 49999 (5 digits). Many applications today require access to all available Modbus registers which range from 400001 to 465535 (6 digits). Watlow controls support 6 digit Modbus registers. For parameters listed as float notice that only one (low order) of the two registers is listed, this is true throughout this document. By default the low order word contains the two low bytes of the 32-bit parameter. As an example, look in the Operations Page for the Analog Input Value. Find the column identified in the header as Modbus Relative Address and notice that it lists register 360. Because this parameter is a float it is actually represented by registers 360 (low order bytes) and 361 (high order bytes). Because the Modbus specification does not dictate which register should be high or low order Watlow provides the user the ability to swap this order (Setup Page, **[COP]** Menu) from the default low/high **[LoHi]** to high/low **[HiLo]**.

#### Note:

With the release of firmware revision 7.00 and above new functions were introduced into the EZ-ZONE product line. With the introduction of these new functions there was a reorganization of Modbus registers. Notice in the column identified as Modbus Relative Address the reference to Map 1 and Map 2 registers for each of the various parameters. To be backwards compatible in your programming use Map 1 registers. To be able to implement new functions in the Limit when and if they become available use Map 2 registers. The Data Map **[MAP]** for Modbus registers can be changed in the Setup Page under the **[COP]** Menu. This setting will apply across the control.

It should also be noted that some of the cells in the Modbus column contain wording pertaining to an offset. Several parameters in the control contain more than one instance; such as, profiles (4), alarms (4), etc... The Modbus register shown always represents instance one. Take for an example the Alarm Silence parameter found in the Setup Page under the Alarm menu. Instance one of Map 1 is shown as address 1490 and +50 is identified as the offset to the next instance. If there was a desire to read or write to instance 3 simply add 100 to 1490 to find its address, in this case, the instance 3 address for Alarm Silence is 1590.

To learn more about the Modbus protocol point your browser to <http://www.modbus.org>.

---

### Common Industrial Protocol (CIP DeviceNet & Ethernet/IP)

Both DeviceNet and EtherNet/IP use open object based programming tools and use the same addressing scheme. In the following menu pages notice the column header identified as CIP. There you will find the Class, Instance and Attribute in hexadecimal, (decimal in parenthesis) which makes up the addressing for both protocols.

Data Types Used with CIP	
int	= Signed 16-bit integer
uint	= Signed 16-bit integer
dint	= Signed 32-bits, long
real	= Float, IEEE 754 32-bit
string	= ASCII, 8 bits per character
sint	= Signed 8 bits , byte

To learn more about the DeviceNet and EtherNet/IP protocol point your browser to <http://www.odva.org>.

## Profibus DP

To accommodate for Profibus DP addressing the following menus contain a column identified as Profibus Index. Data types used in conjunction with Profibus DP can be found in the table below.

<b>Data Types Used with Profibus</b>	
real	= Float, IEEE 754 32-bit
int	= Signed 16-bit integer
byte	= 8-bits

To learn more about the Profibus DP protocol point your browser to <http://www.profibus.org>.

# 5

## Chapter 5: Operations Page

### Navigating the Operations Page

To navigate to the Operations Page, follow the steps below:

1. From the Home Page, press both the Up ▲ and Down ▼ keys for three seconds. **R** will appear in the upper display and **OPER** will appear in the lower display.
2. Press the Up ▲ or Down ▼ key to view available menus.
3. Press the Advance Key → to enter the menu of choice.
4. If a submenu exists (more than one instance), press the Up ▲ or Down ▼ key to select and then press the Advance Key → to enter.
5. Press the Up ▲ or Down ▼ key to move through available menu prompts.
6. Press the Reset Key ⏪ to move backwards through the levels: parameter to submenu; submenu to menu; menu to Home Page.
7. Press and hold the Reset Key ⏪ for two seconds to return to the Home Page.

On the following pages, top level menus are identified with a yellow background color.

#### Note:

Some of these menus and parameters may not appear, depending on the controller's options. See model number information in the Appendix for more information. If there is only one instance of a menu, no submenus will appear.

#### Note:

Some of the listed parameters may not be visible. Parameter visibility is dependent upon controller part number.

- R** Analog Input Menu
  - R<sub>in</sub>** Analog Input Value
  - ER** Input Error
  - CR** Calibration Offset
- d<sub>io</sub>** Digital Input/Output Menu
  - S**
  - d<sub>io</sub>** Digital I/O (5 to 6)
    - d<sub>o5</sub>** Output State
    - d<sub>i5</sub>** Input State
    - E<sub>i5</sub>** Event Status
- L<sub>ln</sub>** Limit Menu
  - LLS** Limit Low Set Point
  - LHS** Limit High Set Point
  - LCR** Limit Clear Request \*
  - LSE** Limit State \*
- RL<sub>ln</sub>** Alarm Menu
  - I**
  - RL<sub>ln</sub>** Alarm (1 to 4)
    - RL<sub>o</sub>** Low Set Point
    - RH<sub>i</sub>** High Set Point
    - RL<sub>LR</sub>** Clear Request \*
    - RS<sub>ir</sub>** Silence Request\*
    - RSE** State \*

Operations Page

Display	Parameter Name Description	Range	Default	Modbus Relative Address	CIP Class Instance Attribute hex (dec)	Pro-fibus Index	Parameter ID	Data Type & Read/Write
<div style="border: 1px solid black; padding: 2px;"> <span style="border: 1px solid black; padding: 1px;">A</span> <span style="border: 1px solid black; padding: 1px;">OPER</span>  <b>Analog Input Menu</b> </div>								
<div style="border: 1px solid black; padding: 2px;"> <span style="border: 1px solid black; padding: 1px;">A</span> <span style="border: 1px solid black; padding: 1px;">In</span>                      [ i.Ain]                 </div>	Analog Input (1) <b>Analog Input Value</b> View the process value. <b>Note:</b> Ensure that the Input Error (below) indicates no error (61) when reading this value using a field bus protocol. If an error exists, the last known value prior to the error occurring will be returned.	-1,999.000 to 9,999.000°F or units -1,128.000 to 5,537.000°C	----	<b>Instance 1</b> Map 1    Map 2 360      360	0x68 (104) 1 1	0	4001	float R
<div style="border: 1px solid black; padding: 2px;"> <span style="border: 1px solid black; padding: 1px;">i</span> <span style="border: 1px solid black; padding: 1px;">Er</span>                      [ i.Er]                 </div>	Analog Input (1) <b>Input Error</b> View the cause of the most recent error. If the <span style="border: 1px solid black; padding: 1px;">REtEn</span> message is <span style="border: 1px solid black; padding: 1px;">Er.i</span> , this parameter will display the cause of the input error.	<span style="border: 1px solid black; padding: 1px;">nonE</span> None (61) <span style="border: 1px solid black; padding: 1px;">OPEN</span> Open (65) <span style="border: 1px solid black; padding: 1px;">FRIL</span> Fail (32) <span style="border: 1px solid black; padding: 1px;">Shrt</span> Shorted (127) <span style="border: 1px solid black; padding: 1px;">ErM</span> Measurement Error (140) <span style="border: 1px solid black; padding: 1px;">ECAL</span> Bad Calibration Data (139) <span style="border: 1px solid black; padding: 1px;">ErAb</span> Ambient Error (9) <span style="border: 1px solid black; padding: 1px;">ErEd</span> RTD Error (141) <span style="border: 1px solid black; padding: 1px;">NSrc</span> Not Sourced (246)	None	<b>Instance 1</b> Map 1    Map 2 362      362	0x68 (104) 1 2	1	4002	uint R
<div style="border: 1px solid black; padding: 2px;"> <span style="border: 1px solid black; padding: 1px;">i</span> <span style="border: 1px solid black; padding: 1px;">CA</span>                      [ i.CA]                 </div>	Analog Input (1) <b>Calibration Offset</b> Offset the input reading to compensate for lead wire resistance or other factors that cause the input reading to vary from the actual process value.	-1,999.000 to 9,999.000°F or units -1,110.555 to 5,555.000°C	0.0	<b>Instance 1</b> Map 1    Map 2 382      382	0x68 (104) 1 0xC (12)	2	4012	float RWES
<div style="border: 1px solid black; padding: 2px;"> <span style="border: 1px solid black; padding: 1px;">d</span> <span style="border: 1px solid black; padding: 1px;">O</span>  <span style="border: 1px solid black; padding: 1px;">OPER</span>  <b>Digital Input/Output Menu</b> </div>								
<div style="border: 1px solid black; padding: 2px;"> <span style="border: 1px solid black; padding: 1px;">do</span> <span style="border: 1px solid black; padding: 1px;">S</span>                      [ do.S]                 </div>	Digital Output (5 to 6) <b>Output State</b> View the state of this output.	<span style="border: 1px solid black; padding: 1px;">OFF</span> Off (62) <span style="border: 1px solid black; padding: 1px;">on</span> On (63)	----	<b>Instance 5</b> Map 1    Map 2 1012     1132 Offset to next instance equals +30	0x6A (106) 5 to 6 7	90	6007	uint R
<div style="border: 1px solid black; padding: 2px;"> <span style="border: 1px solid black; padding: 1px;">di</span> <span style="border: 1px solid black; padding: 1px;">S</span>                      [ di.S]                 </div>	Digital Input (5 to 6) <b>Input State</b> View this event input state.	<span style="border: 1px solid black; padding: 1px;">OFF</span> Off (62) <span style="border: 1px solid black; padding: 1px;">on</span> On (63)	----	<b>Instance 5</b> Map 1    Map 2 1020     1140 Offset to next instance equals +30	0x6A (106) 5 to 6 0xB (11)	----	6011	uint R
<b>Note:</b> Some values will be rounded off to fit in the four-character display. Full values can be read with other interfaces.								R: Read W: Write E: EEPROM S: User Set

Operations Page

Display	Parameter Name Description	Range	Default	Modbus Relative Address	CIP Class Instance Attribute hex (dec)	Pro-fibus Index	Parameter ID	Data Type & Read/Write
<input type="checkbox"/> <b>E.S</b> [ Ei.S]	<i>Digital Input (5 to 6)</i> <b>Event Status</b> View this event input state.	<input type="checkbox"/> <b>oFF</b> Off (62) <input type="checkbox"/> <b>on</b> On (63)	----	<b>Instance 5</b> <i>Map 1 Map 2</i> 1408 1648 Offset to next instance equals +20	0x6E (110) 5 to 6 5	140	10005	uint R
No Display	<i>EZ-Key/s (1 to 2)</i> <b>Event Status</b> View this event input state.	<input type="checkbox"/> <b>oFF</b> Off (62) <input type="checkbox"/> <b>on</b> On (63)	----	<b>Instance 1</b> <i>Map 1 Map 2</i> 1328 1568 <b>Instance 2</b> <i>Map 1 Map 2</i> 1348 1588	0x6E (110) 3 to 4 5	140	10005	uint R
<input type="checkbox"/> <b>L.PP</b> <input type="checkbox"/> <b>oPEr</b> <b>Limit Menu</b>								
<input type="checkbox"/> <b>LLS</b> [ LL.S]	<i>Limit (1)</i> <b>Limit Low Set Point</b> Set the low process value that will trigger the limit.	-1,999.000 to 9,999.000°F or units -1,128.000 to 5,537.000°C	0.0°F or units -18.0°C	<b>Instance 1</b> <i>Map 1 Map 2</i> 684 724	0x70 (112) 1 3	38	12003	float RWES
<input type="checkbox"/> <b>LhS</b> [ Lh.S]	<i>Limit (1)</i> <b>Limit High Set Point</b> Set the high process value that will trigger the limit.	-1,999.000 to 9,999.000°F or units -1,128.000 to 5,537.000°C	0.0°F or units -18.0°C	<b>Instance 1</b> <i>Map 1 Map 2</i> 686 726	0x70 (112) 1 4	39	12004	float RWES
<input type="checkbox"/> <b>LCr</b> [ L.Cr]	<i>Limit (1)</i> <b>Limit Clear Request</b> Clear limit once limit condition is cleared.	<input type="checkbox"/> <b>CLr</b> Clear (0) <input type="checkbox"/> <b>Ignr</b> Ignore (204)	0	<b>Instance 1</b> <i>Map 1 Map 2</i> 680 720	0x70 (112) 1 1	----	12001	uint W
<input type="checkbox"/> <b>LSE</b> [ L.St]	<i>Limit (1)</i> <b>Limit State</b> Clear limit once limit condition is cleared.	<input type="checkbox"/> <b>oFF</b> Off (62) <input type="checkbox"/> <b>nonE</b> None (61) <input type="checkbox"/> <b>L.h</b> Limit High (51) <input type="checkbox"/> <b>L.lL</b> Limit Low (52) <input type="checkbox"/> <b>Errr</b> Error (28)	----	<b>Instance 1</b> <i>Map 1 Map 2</i> 690 730	0x70 (112) 1 6	----	12006	uint R
<input type="checkbox"/> <b>RLPP</b> <input type="checkbox"/> <b>oPEr</b> <b>Alarm Menu</b>								
<input type="checkbox"/> <b>RLo</b> [ A.Lo]	<i>Alarm (1 to 4)</i> <b>Alarm Low Set Point</b> If Alarm Type (Setup Page, Alarm Menu) is set to: <b>process</b> - set the process value that will trigger a low alarm.	-1,999.000 to 9,999.000°F or units -1,128.000 to 5,537.000°C	32.0°F or units 0.0°C	<b>Instance 1</b> <i>Map 1 Map 2</i> 1482 1882  Offset to next instance ( <i>Map 1</i> ) equals +50  Offset to next instance ( <i>Map 2</i> ) equals +60	0x6D (109) 1 to 4 2	18	9002	float RWES
<b>Note:</b> Some values will be rounded off to fit in the four-character display. Full values can be read with other interfaces.								<b>R:</b> Read <b>W:</b> Write <b>E:</b> EEPROM <b>S:</b> User Set

Operations Page

Display	Parameter Name Description	Range	Default	Modbus Relative Address	CIP Class Instance Attribute hex (dec)	Pro-fibus Index	Parameter ID	Data Type & Read/Write
<b>Ah</b> [A.hi]	<b>Alarm (1 to 4) Alarm High Set Point</b> If Alarm Type (Setup Page, Alarm Menu) is set to: <b>process</b> - set the process value that will trigger a high alarm.	-1,999.000 to 9,999.000°F or units -1,128.000 to 5,537.000°C	300.0°F or units 150.0°C	<b>Instance 1</b> <i>Map 1</i> <i>Map 2</i> 1480 1880  Offset to next instance ( <i>Map 1</i> ) equals +50  Offset to next instance ( <i>Map 2</i> ) equals +60	0x6D (109) 1 to 4 1	19	9001	float RWES
<b>CLr</b> [A.Clr]	<b>Alarm (1 to 4) Alarm Clear Request</b> Write to this register to clear an alarm  <b>Note:</b> If an alarm is setup to latch when active <b>CLr</b> will appear on the display.	<b>CLr</b> Clear (0) <b>Ignr</b> Ignore (204)	----	<b>Instance 1</b> <i>Map 1</i> <i>Map 2</i> 1504 1904  Offset to next instance ( <i>Map 1</i> ) equals +50, <i>Map 2</i> equals +60)	0x6D (109) 1 to 4 0xD (13)	----	9013	uint W
<b>Sir</b> [A.Sir]	<b>Alarm (1 to 4) Alarm Silence Request</b> Write to this register to silence an alarm  <b>Note:</b> If an alarm is setup to silence alarm when active <b>Sir</b> will appear on the display.	<b>Sil</b> Silence (1010)	0	<b>Instance 1</b> <i>Map 1</i> <i>Map 2</i> 1506 1906  Offset to next instance ( <i>Map 1</i> ) equals +50, <i>Map 2</i> equals +60)	0x6D (109) 1 to 4 0xE (14)	----	9014	uint W
<b>SE</b> [A.St]	<b>Alarm (1 to 4) Alarm State</b> Current state of alarm	<b>SEr</b> Startup (88) <b>nonE</b> None (61) <b>blO</b> Blocked (12) <b>ALl</b> Alarm low (8) <b>ALh</b> Alarm high (7) <b>Err</b> Error (28)	None	<b>Instance 1</b> <i>Map 1</i> <i>Map 2</i> 1496 1896  Offset to next instance [ <i>Map 1</i> +50], [ <i>Map 2</i> +60]	0x6D (109) 1 to 4 9	----	9009	uint R
No Displayed	<b>Alarm (1 to 4) Alarm Clearable</b> Current state of alarm	<b>no</b> No (59) <b>YES</b> Yes (106)	----	<b>Instance 1</b> <i>Map 1</i> <i>Map 2</i> 1502 1902  Offset to next instance ( <i>Map 1</i> ) equals +50, <i>Map 2</i> equals +60)	0x6D (109) 1 to 4 0xC (12)	----	9012	uint R
<b>Note:</b> Some values will be rounded off to fit in the four-character display. Full values can be read with other interfaces.								R: Read W: Write E: EEPROM S: User Set

Operations Page

Display	Parameter Name Description	Range	Default	Modbus Relative Address	CIP Class Instance Attribute hex (dec)	Pro-fibus Index	Parameter ID	Data Type & Read/Write
No Displayed	<i>Alarm (1 to 4)</i> <b>Alarm Silenced</b> Write to this register to silence an alarm	<input type="checkbox"/> <b>no</b> No (59) <input type="checkbox"/> <b>YES</b> Yes (106)	----	<b>Instance 1</b> <i>Map 1</i> <i>Map 2</i> 1500    1900  Offset to next instance (Map1 1 equals +50, Map 2 equals +60)	0x6D (109) 1 to 4 0x0B (11)	----	9011	uint R
No Displayed	<i>Alarm (1 to 4)</i> <b>Alarm Latched</b> Write to this register to silence an alarm	<input type="checkbox"/> <b>no</b> No (59) <input type="checkbox"/> <b>YES</b> Yes (106)	----	<b>Instance 1</b> <i>Map 1</i> <i>Map 2</i> 1498    1898  Offset to next instance (Map1 1 equals +50, Map 2 equals +60)	0x6D (109) 1 to 4 0x0A (10)	----	9010	uint R
<b>Note:</b> Some values will be rounded off to fit in the four-character display. Full values can be read with other interfaces.								R: Read W: Write E: EEPROM S: User Set



# 6

## Chapter 6: Setup Page

### Navigating the Setup Page

To navigate to the Setup Page, follow the steps below:

1. From the Home Page, press both the Up and Down keys for six seconds. will appear in the upper display and will appear in the lower display.
2. Press the Up or Down key to view available menus.
3. Press the Advance Key to enter the menu of choice.
4. If a submenu exists (more than one instance), press the Up or Down key to select and then press the Advance Key to enter.
5. Press the Up or Down key to move through available menu prompts.
6. Press the Reset Key to move backwards through the levels: parameter to submenu; submenu to menu; menu to Home Page.
7. Press and hold the Reset Key for two seconds to return to the Home Page.

On the following pages, top level menus are identified with a yellow background color.

#### Note:

Keys must be held continuously until is displayed in green. If keys are released when is displayed, press the infinity key or reset key to exit and repeat until is displayed.

#### Note:

Some of these menus and parameters may not appear, depending on the controller's options. See model number information in the Appendix for more information. If there is only one instance of a menu, no sub-menus will appear.

#### Note:

Some of the listed parameters may not be visible. Parameter visibility is dependent upon controller part number.

	Output Function Instance	Scale Low
Analog Input Menu	Active Level	Scale High
Sensor Type	Action Function	Range Low
TC Linearization	Function Instance	Range High
RTD Leads		Calibration Offset
Units		
Scale Low	Limit Menu	
Scale High	Limit Sides	Alarm Menu
Range Low	Limit Hysteresis	
Range High	Set Point High Limit	Alarm (1 to 4)
Process Error Enable	Set Point Low Limit	Alarm Type
Process Error Low Value	Limit High Set Point *	Alarm Source
Thermistor Curve	Limit Low Set Point *	Alarm Source Instance A
Resistance Range	Source Function A *	Alarm Hysteresis
Filter	Source Instance A *	Alarm Logic
Input Error Latching	Limit Clear Request *	Alarm Sides
Display Precision	Limit Status *	Alarm Low Set Point *
Calibration Offset *		Alarm High Set Point *
Analog Input Value *		Alarm Latching
Input Error Status *	Output Menu	Alarm Blocking
		Alarm Silencing
	Output (1 to 4)	Alarm Display
Digital Input/Output Menu	Output Function	Alarm Delay Time
	Output Function Instance	Alarm Clear Request *
Digital I/O (5 to 6)	Output 3 process	Alarm Silence Request *
Digital I/O Direction	Output Type	Alarm State *
Output Function	Output Function	
	Output Function Instance	

\* These parameters/prompts are available with firmware revisions 11.0 and above.

**FUn**  
**SEt** Function Key Menu

- FUn** Function Key (1 to 2)
- LEu** Active Level
- Fn** Action Function
- F, I** Function Instance

**9LbL**  
**SEt** Global Menu

- C\_F** Display Units
- CLEd** Communications LED Action
- ZonE** Zone
- ChRn** Channel
- dPrS** Display Pairs
- dE, I** Display Time
- USr.S** User Settings Save
- USr.r** User Settings Restore

**COPn**  
**SEt** Communications Menu

- COPn** Communications (1 to 2)
- PcOL** Protocol
- RdS** Standard Bus Address
- bRUD** Baud Rate
- PRr** Parity
- r7hL** Modbus Word Order
- ,P7n** IP Address Mode
- ,PF1** IP Fixed Address Part 1
- ,PF2** IP Fixed Address Part 2
- ,PF3** IP Fixed Address Part 3
- ,PF4** IP Fixed Address Part 4
- ,PS1** IP Fixed Subnet Part 1
- ,PS2** IP Fixed Subnet Part 2
- ,PS3** IP Fixed Subnet Part 3
- ,PS4** IP Fixed Subnet Part 4
- ,P91** IP Fixed Gateway Part 1
- ,P92** IP Fixed Gateway Part 2
- ,P93** IP Fixed Gateway Part 3
- ,P94** IP Fixed Gateway Part 4
- r7bE** Modbus TCP Enable
- E,PE** EtherNet/IP Enable
- Ranb** CIP Implicit Assembly Output Member Quantity
- R,wb** CIP Implicit Assembly Input Member Quantity
- C\_F** Display Units
- r7RP** Data Map
- nvS** Non-Volatile Save

Setup Page

Display	Parameter Name Description	Range	Default	Modbus Relative Address	CIP Class Instance Attribute hex (dec)	Profibus Index	Parameter ID	Data Type & Read/Write
<input type="checkbox"/> <b>A</b> , <input type="checkbox"/> <b>SEt</b> <b>Analog Input Menu</b>								
<input type="checkbox"/> <b>SEn</b> [SEn]	<b>Analog Input (1)</b> <b>Sensor Type</b> Set the analog sensor type to match the device wired to this input.  <b>Note:</b> There is no open-sensor detection for process inputs.	<input type="checkbox"/> <b>oFF</b> Off (62) <input type="checkbox"/> <b>Et</b> Thermocouple (95) <input type="checkbox"/> <b>r7u</b> Millivolts (56) <input type="checkbox"/> <b>uolt</b> Volts dc (104) <input type="checkbox"/> <b>r7A</b> Milliamps dc (112) <input type="checkbox"/> <b>r0.1H</b> RTD 100 Ω (113) <input type="checkbox"/> <b>r1.0H</b> RTD 1,000 Ω (114) <input type="checkbox"/> <b>Pot</b> Potentiometer 1 kΩ (155) <input type="checkbox"/> <b>thEr</b> Thermistor (229)	Off	<b>Instance 1</b> <i>Map 1</i> <i>Map 2</i> 368      368	0x68 (104) 1 5	3	4005	uint RWES
<input type="checkbox"/> <b>Lin</b> [Lin]	<b>Analog Input (1)</b> <b>TC Linearization</b> Set the linearization to match the thermocouple wired to this input.	<input type="checkbox"/> <b>b</b> B (11) <input type="checkbox"/> <b>H</b> K (48) <input type="checkbox"/> <b>C</b> C (15) <input type="checkbox"/> <b>n</b> N (58) <input type="checkbox"/> <b>d</b> D (23) <input type="checkbox"/> <b>r</b> R (80) <input type="checkbox"/> <b>E</b> E (26) <input type="checkbox"/> <b>S</b> S (84) <input type="checkbox"/> <b>F</b> F (30) <input type="checkbox"/> <b>T</b> T (93) <input type="checkbox"/> <b>J</b> J (46)	J	<b>Instance 1</b> <i>Map 1</i> <i>Map 2</i> 370      370	0x68 (104) 1 6	4	4006	uint RWES
<input type="checkbox"/> <b>rt.L</b> [rt.L]	<b>Analog Input (1)</b> <b>RTD Leads</b> Set to match the number of leads on the RTD wired to this input.	<input type="checkbox"/> <b>2</b> 2 (1) <input type="checkbox"/> <b>3</b> 3 (2)	2	<b>Instance 1</b> <i>Map 1</i> <i>Map 2</i> 372      368	0x68 (104) 1 7	- - - -	4007	uint RWES
<input type="checkbox"/> <b>Unit</b> [Unit]	<b>Analog Input (1)</b> <b>Units</b> Set the type of units the sensor will measure.	<input type="checkbox"/> <b>ATP</b> Absolute Temperature (1540) <input type="checkbox"/> <b>rh</b> Relative Humidity (1538) <input type="checkbox"/> <b>Pro</b> Process (75) <input type="checkbox"/> <b>PLUr</b> Power (73)	Process	<b>Instance 1</b> <i>Map 1</i> <i>Map 2</i> - - - -    442	0x68 (104) 1 0x2A (42)	5	4042	uint RWES
<input type="checkbox"/> <b>S.Lo</b> [S.Lo]	<b>Analog Input (1)</b> <b>Scale Low</b> Set the low scale for process inputs. This value, in millivolts, volts or milliamps, will correspond to the Range Low output of this function block.	-100.0 to 1,000.0	0.0	<b>Instance 1</b> <i>Map 1</i> <i>Map 2</i> 388      388	0x68 (104) 1 0xF (15)	6	4015	float RWES
<input type="checkbox"/> <b>S.hi</b> [S.hi]	<b>Analog Input (1)</b> <b>Scale High</b> Set the high scale for process inputs. This value, in millivolts, volts or milliamps, will correspond to the Range High output of this function block.	-100.0 to 1,000.0	20.0	<b>Instance 1</b> <i>Map 1</i> <i>Map 2</i> 390      390	0x68 (104) 1 to 4 0x10 (16)	7	4016	float RWES
<b>Note:</b> Some values will be rounded off to fit in the four-character display. Full values can be read with other interfaces.  * These parameters/prompts are available in this menu with firmware revisions 11.0 and above.								R: Read W: Write E: EEPROM S: User Set

Setup Page

Display	Parameter Name Description	Range	Default	Modbus Relative Address	CIP Class Instance Attribute hex (dec)	Pro-fibus Index	Parameter ID	Data Type & Read/Write
<input type="text" value="r.Lo"/> [ r.Lo]	<i>Analog Input (1)</i> <b>Range Low</b> Set the low range for this function block's output.	-1,999.000 to 9,999.000	0.0	<b>Instance 1</b> Map 1 Map 2 392 392	0x68 (104) 1 0x11 (17)	8	4017	float RWES
<input type="text" value="r.hi"/> [ r.hi]	<i>Analog Input (1)</i> <b>Range High</b> Set the high range for this function block's output.	-1,999.000 to 9,999.000	9,999	<b>Instance 1</b> Map 1 Map 2 394 394	0x68 (104) 1 0x12 (18)	9	4018	float RWES
<input type="text" value="P.EE"/> [ P.EE]	<i>Analog Input (1)</i> <b>Process Error Enable</b> Turn the Process Error Low feature on or off.	<input type="text" value="OFF"/> Off (62) <input type="text" value="Low"/> Low (53)	Off	<b>Instance 1</b> Map 1 Map 2 418 418	0x68 (104) 1 0x1E (30)	10	4030	uint RWES
<input type="text" value="P.E.L"/> [ P.E.L]	<i>Analog Input (1)</i> <b>Process Error Low Value</b> If the process value drops below this value, it will trigger an input error.	-100.0 to 1,000.0	0.0	<b>Instance 1</b> Map 1 Map 2 420 420	0x68 (104) 1 0x1F (31)	11	4031	float RWES
<input type="text" value="t.C"/> [ t.C]	<i>Analog Input (1)</i> <b>Thermistor Curve</b> Select a curve to apply to the thermistor input.	<input type="text" value="A"/> Curve A (1451) <input type="text" value="b"/> Curve B (1452) <input type="text" value="C"/> Curve C (1453) <input type="text" value="CUSE"/> Custom (180)	Curve A	<b>Instance 1</b> Map 1 Map 2 434 434	0x68 (104) 1 20x6 (38)	----	4038	uint RWES
<input type="text" value="r.r"/> [ r.r]	<i>Analog Input (1)</i> <b>Resistance Range</b> Set the maximum resistance of the thermistor input.	<input type="text" value="5"/> 5K (1448) <input type="text" value="10"/> 10K (1360) <input type="text" value="20"/> 20K (1361) <input type="text" value="40"/> 40K (1449)	40K	<b>Instance 1</b> Map 1 Map 2 432 432	0x68 (104) 1 0x25 (37)	----	4037	uint RWES
<input type="text" value="FiL"/> [ FiL]	<i>Analog Input (1)</i> <b>Filter</b> Filtering smooths out the process signal to both the display and the input. Increase the time to increase filtering.	0.0 to 60.0 seconds	0.5	<b>Instance 1</b> Map 1 Map 2 386 386	0x68 (104) 1 0xE (14)	12	4014	float RWES
<input type="text" value="i.Er"/> [ i.Er]	<i>Analog Input (1)</i> <b>Input Error Latching</b> Turn input error latching on or off. If latching is on, errors must be manually cleared.	<input type="text" value="OFF"/> Off (62) <input type="text" value="on"/> On (63)	Off	<b>Instance 1</b> Map 1 Map 2 414 414	0x68 (104) 1 to 2 0x1C (28)	----	4028	uint RWES
<input type="text" value="dEC"/> [ dEC]	<i>Analog Input (1)</i> <b>Display Precision</b> Set the precision of the displayed value.	<input type="text" value="0"/> Whole (105) <input type="text" value="00"/> Tenths (94) <input type="text" value="000"/> Hundredths (40) <input type="text" value="0000"/> Thousandths (96)	Whole	<b>Instance 1</b> Map 1 Map 2 398 398	0x68 (104) 1 0x14 (20)	----	4020	uint RWES
<p><b>Note:</b> Some values will be rounded off to fit in the four-character display. Full values can be read with other interfaces.</p> <p>* These parameters/prompts are available in this menu with firmware revisions 11.0 and above.</p>								R: Read W: Write E: EEPROM S: User Set

Setup Page

Display	Parameter Name Description	Range	Default	Modbus Relative Address	CIP Class Instance Attribute hex (dec)	Pro-fibus Index	Parameter ID	Data Type & Read/Write
<u>CA</u> [ i.CA]	<i>Analog Input (1)</i> <b>Calibration Offset *</b> Offset the input reading to compensate for lead wire resistance or other factors that cause the input reading to vary from the actual process value.	-1,999.000 to 9,999.000°F or units -1,110.555 to 5,555.000°C	0.0	<b>Instance 1</b> <i>Map 1</i> <i>Map 2</i> 382 382	0x68 (104) 1 0x0C (12)	2	4012	float RWES
<u>AIN</u> [ Ain]	<i>Analog Input (1)</i> <b>Analog Input Value *</b> View the process value. <b>Note:</b> Ensure that the Input Error Status (below) indicates no error (61) when reading this value using a field bus protocol. If an error exists, the last known value prior to the error occurring will be returned.	-1,999.000 to 9,999.000°F or units -1,128.000 to 5,537.000°C	----	<b>Instance 1</b> <i>Map 1</i> <i>Map 2</i> 360 360	0x68 (104) 1 1	0	4001	float R
<u>Er</u> [ i.Er]	<i>Analog Input (1)</i> <b>Input Error Status *</b> View the cause of the most recent error. If the <u>REtE</u> message is <u>Er, i</u> , this parameter will display the cause of the input error.	<u>none</u> None (61) <u>OPEN</u> Open (65) <u>Short</u> Shorted (127) <u>Err</u> Measurement Error (149) <u>ECAL</u> Bad Calibration Data (139) <u>ErrAb</u> Ambient Error (9) <u>Errtd</u> RTD Error (141) <u>FAIL</u> Fail (32) <u>NSrc</u> Not Sourced (246)	None	<b>Instance 1</b> <i>Map 1</i> <i>Map 2</i> 362 362	0x68 (104) 1 2	1	4002	float R
<u>di</u> <u>SEt</u> <b>Digital Input/Output Menu</b>								
<u>dir</u> [ i.dir]	<i>Digital Input/Output (5 to 6)</i> <b>Digital I/O Direction</b> Set this function to operate as an input or output.	<u>DEPE</u> Output (68) <u>Icon</u> Input Dry Contact (44) <u>in</u> Input Voltage (193)	Output	<b>Instance 5</b> <i>Map 1</i> <i>Map 2</i> 1000 1120  Offset to next instance ( <i>Map 1</i> & <i>Map 2</i> ) equals +30	0x6A (106) 5 to 6 1	82	6001	uint RWES
<b>Note:</b> Some values will be rounded off to fit in the four-character display. Full values can be read with other interfaces.  * These parameters/prompts are available in this menu with firmware revisions 11.0 and above.								R: Read W: Write E: EEPROM S: User Set

Setup Page

Display	Parameter Name Description	Range	Default	Modbus Relative Address	CIP Class Instance Attribute hex (dec)	Pro-fibus Index	Parameter ID	Data Type & Read/Write
<input type="checkbox"/> Fn [ Fn]	<i>Digital Output (5 to 6)</i> <b>Digital I/O Function</b> Select what function will drive this output.	<input type="checkbox"/> FF Off (62) <input type="checkbox"/> ALP Alarm (6)	Off	<b>Instance 5</b> Map 1 Map 2 1008 1128	0x6A (106) 5 to 6 5	83	6005	uint RWES
<input type="checkbox"/> Fi [ Fi]	<i>Digital Output (5 to 6)</i> <b>Digital I/O Function Instance</b> Set the instance of the function selected above.	1 to 4	1	<b>Instance 5</b> Map 1 Map 2 1010 1130	0x6A (106) 5 to 6 6	84	6006	uint RWES
<input type="checkbox"/> LEv [ LEv]	<i>Digital Input (5 to 6)</i> <b>Active Level</b> Select which action will be interpreted as a true state.	<input type="checkbox"/> H,9h High (37) <input type="checkbox"/> LoL Low (53)	High	<b>Instance 5</b> Map 1 Map 2 1320 1560	0x6E (110) 5 to 6 1	137	10001	uint RW
<input type="checkbox"/> Fn [ Fn]	<i>Digital Input (5 to 6)</i> <b>Action Function</b> Select the function that will be triggered by a true state.	<input type="checkbox"/> nonE None (61) <input type="checkbox"/> LPL Limit Reset, edge triggered (82) <input type="checkbox"/> FAL Force Alarm To Occur, level triggered (218) <input type="checkbox"/> RoF Control Loops Off and Alarms to Non-alarm State, level triggered (220) <input type="checkbox"/> S,L Silence Alarms, edge triggered (108) <input type="checkbox"/> ALP Alarm (6) <input type="checkbox"/> PLoc Keypad Lockout, level triggered (217) <input type="checkbox"/> USrr User Settings Restore, edge triggered (227)	None	<b>Instance 5</b> Map 1 Map 2 1324 1564	0x6E (110) 5 to 6 3	138	10003	uint RWES
<input type="checkbox"/> Fi [ Fi]	<i>Digital Input (5 to 6)</i> <b>Function Instance</b> Select which instance of the Event Function that will be triggered by a true state.	0 to 4	0	<b>Instance 5</b> Map 1 Map 2 1326 1566	0x6E (110) 5 to 6 4	139	10004	uint RWES
<p><b>Note:</b> Some values will be rounded off to fit in the four-character display. Full values can be read with other interfaces.</p> <p>* These parameters/prompts are available in this menu with firmware revisions 11.0 and above.</p>								R: Read W: Write E: EEPROM S: User Set

Setup Page

Display	Parameter Name Description	Range	Default	Modbus Relative Address	CIP Class Instance Attribute hex (dec)	Pro-fibus Index	Parameter ID	Data Type & Read/Write
<div style="border: 1px solid black; padding: 2px;"> <span style="border: 1px solid black; padding: 1px;">L, P P</span>  <span style="border: 1px solid black; padding: 1px;">SEt</span>  <b>Limit Menu</b> </div>								
<span style="border: 1px solid black; padding: 1px;">L.Sd</span> [ L.Sd]	<i>Limit (1)</i> <b>Limit Sides</b> Select which side or sides of the process value will be monitored.	<span style="border: 1px solid black; padding: 1px;">both</span> Both (13) <span style="border: 1px solid black; padding: 1px;">h, 9h</span> High (37) <span style="border: 1px solid black; padding: 1px;">LoLl</span> Low (53)	Both	<b>Instance 1</b> <i>Map 1</i> <i>Map 2</i> 688 728	0x70 (112) 1 5	40	12005	uint RWES
<span style="border: 1px solid black; padding: 1px;">L.h</span> [ L.hy]	<i>Limit (1)</i> <b>Limit Hysteresis</b> Set the hysteresis for the limit function. This determines how far into the safe range the process value must move before the limit can be cleared.	0.001 to 9,999.000°F or units 0.001 to 5,555.000°C	3.0°F or units 2.0°C	<b>Instance 1</b> <i>Map 1</i> <i>Map 2</i> 682 722	0x70 (112) 1 2	41	12002	float RWES
<span style="border: 1px solid black; padding: 1px;">SP.Lh</span> [SP.Lh]	<i>Limit (1)</i> <b>Set Point High Limit</b> Set the high end of the limit set point range.	-1,999.000 to 9,999.000	9,999.000	<b>Instance 1</b> <i>Map 1</i> <i>Map 2</i> 696 736	0x70 (112) 1 9	42	12009	float RWES
<span style="border: 1px solid black; padding: 1px;">SP.Ll</span> [SP.Ll]	<i>Limit (1)</i> <b>Set Point Low Limit</b> Set the low end of the limit set point range.	-1,999.000 to 9,999.000	-1,999.000	<b>Instance 1</b> <i>Map 1</i> <i>Map 2</i> 698 738	0x70 (112) 1 0x0A (10)	43	12010	float RWES
<span style="border: 1px solid black; padding: 1px;">L.h.S</span> [ Lh.S]	<i>Limit (1)</i> <b>Limit High Set Point *</b> * Set the high process value that will trigger the limit.	-1,999.000 to 9,999.000°F or units -1,128.000 to 5,537.000°C	0.0°F or units -18.0°C	<b>Instance 1</b> <i>Map 1</i> <i>Map 2</i> 686 726	0x70 (112) 1 4	39	12004	float RWES
<span style="border: 1px solid black; padding: 1px;">LL.S</span> [ LL.S]	<i>Limit (1)</i> <b>Limit Low Set Point *</b> * Set the low process value that will trigger the limit.	-1,999.000 to 9,999.000°F or units -1,128.000 to 5,537.000°C	0.0°F or units -18.0°C	<b>Instance 1</b> <i>Map 1</i> <i>Map 2</i> 684 724	0x70 (112) 1 3	38	12003	float RWES
<span style="border: 1px solid black; padding: 1px;">SF.n.P</span> [SF.n.A]	<i>Limit (1)</i> <b>Source Function A *</b> Set the source for the limit reset function.	<span style="border: 1px solid black; padding: 1px;">nonE</span> None (61) <span style="border: 1px solid black; padding: 1px;">d i o</span> Digital I/O (1142) <span style="border: 1px solid black; padding: 1px;">FUn</span> Function Key (1001)	None	----	0x70 (112) 1 0x0F (15)	----	12015	uint RWES
<span style="border: 1px solid black; padding: 1px;">S .P</span> [ St.A]	<i>Limit (1)</i> <b>Source Instance A *</b> Set the instance of the function selected above.  <i>Instance Usage:</i> - EZ-Function Keys, 1 and 2 - Digital I/O, 5 through 12	1 to 12	1	----	0x70 (112) 1 0x10 (16)	----	12016	uint RWES
<b>Note:</b> Some values will be rounded off to fit in the four-character display. Full values can be read with other interfaces.  * These parameters/prompts are available in this menu with firmware revisions 11.0 and above.								R: Read W: Write E: EEPROM S: User Set

Setup Page

Display	Parameter Name Description	Range	Default	Modbus Relative Address	CIP Class Instance Attribute hex (dec)	Pro-fibus Index	Parameter ID	Data Type & Read/Write
<input type="checkbox"/> LCr [ LCr]	<i>Limit (1)</i> <b>Limit Clear Request</b> * Clear limit once limit condition is cleared.	<input type="checkbox"/> LCr Clear (0) <input type="checkbox"/> Ignr Ignore (204)	----	<b>Instance 1</b> <i>Map 1</i> <i>Map 2</i> 680 720	0x70 (112) 1 1	----	12001	uint W
<input type="checkbox"/> LSt [ LSt]	<i>Limit (1)</i> <b>Limit Status</b> * Reflects whether or not the limit is in a safe or failed mode.	<input type="checkbox"/> Fail Fail (32) <input type="checkbox"/> Safe Safe (1667)	----	<b>Instance 1</b> <i>Map 1</i> <i>Map 2</i> ---- 744	0x70 (112) 1 0x0D (13)	----	12013	uint R
No Display	<i>Limit (1)</i> <b>Limit State</b> Clear limit once limit condition is cleared.	<input type="checkbox"/> Off Off (62) <input type="checkbox"/> None None (61) <input type="checkbox"/> Limh Limit High (51) <input type="checkbox"/> Liml Limit Low (52) <input type="checkbox"/> Err Error (28)	----	<b>Instance 1</b> <i>Map 1</i> <i>Map 2</i> 690 730	0x70 (112) 1 6	----	12006	uint R
<input type="checkbox"/> OptE <input type="checkbox"/> SEt <b>Output Menu</b>								
<input type="checkbox"/> Fn [ Fn]	<i>Output Digital (1 to 4)</i> <b>Output Function</b> Select what function will drive this output.  <b>Note:</b> Output 2 is always a limit. Use as primary limit connection.	<input type="checkbox"/> Off Off (62) <input type="checkbox"/> Lim Limit (126) <input type="checkbox"/> Alr Alarm (6)	Output 1 - Alarm Output 2 - Limit Output 3 - Off Output 4 - Off	<b>Instance 1</b> <i>Map 1</i> <i>Map 2</i> 888 1008	0x6A (106) 1 to 4 5	83	6005	uint RWES
<input type="checkbox"/> Fi [ Fi]	<i>Output Digital (1 to 4)</i> <b>Output Function Instance</b> Set the instance of the function selected above.	1 to 4	1	<b>Instance 1</b> <i>Map 1</i> <i>Map 2</i> 890 1010	0x6A (106) 1 to 4 6	84	6006	uint RWES
<input type="checkbox"/> oTy [ oTy]	<i>Output Process (3)</i> <b>Output Type</b> Select whether the process output will operate in volts or milliamps.	<input type="checkbox"/> Volts Volts (104) <input type="checkbox"/> Mill Milliamps (112)	Volts	<b>Instance 3</b> <i>Map 1</i> <i>Map 2</i> 720 840	0x76 (118) 3 1	95	18001	uint RWES
<input type="checkbox"/> Fn [ Fn]	<i>Output Process (3)</i> <b>Output Function</b> Set the type of function that will drive this output.	<input type="checkbox"/> Off Off (62) <input type="checkbox"/> Retr Retransmit (213) <input type="checkbox"/> OutB Event Out B (234) <input type="checkbox"/> OutA Event Out A (233) <input type="checkbox"/> Alr Alarm (6)	Off	<b>Instance 3</b> <i>Map 1</i> <i>Map 2</i> 722 842 <b>Instance 3</b> <i>Map 1</i> <i>Map 2</i> 802 922	0x76 (118) 3 2	96	18002	uint RWES
<input type="checkbox"/> rSr [ rSr]	<i>Output Process (3)</i> <b>Retransmit Source</b> Select the value that will be retransmitted.	<input type="checkbox"/> Ai Analog Input (142)	Analog Input	<b>Instance 3</b> <i>Map 1</i> <i>Map 2</i> 804 924	0x76 (118) 3 3	97	18003	uint RWES
<b>Note:</b> Some values will be rounded off to fit in the four-character display. Full values can be read with other interfaces.  * These parameters/prompts are available in this menu with firmware revisions 11.0 and above.								<b>R:</b> Read <b>W:</b> Write <b>E:</b> EEPROM <b>S:</b> User Set



Setup Page

Display	Parameter Name Description	Range	Default	Modbus Relative Address	CIP Class Instance Attribute hex (dec)	Pro-fibus Index	Parameter ID	Data Type & Read/Write
<b>F</b> , [ Fi]	<i>Output Process (3)</i> <b>Output Function Instance</b> Set the instance of the function selected above.	1 to 4	1	<b>Instance 3</b> <i>Map 1</i> <i>Map 2</i> 806 926	0x76 (118) 3 4	98	18004	uint RWES
<b>S.Lo</b> [ S.Lo]	<i>Output Process (3)</i> <b>Scale Low</b> Set the scale low for process output in electrical units. This value; in volts or milliamps, will correspond to range low value.	-100.0 to 100.0	0.00	<b>Instance 3</b> <i>Map 1</i> <i>Map 2</i> 816 936	0x76 (118) 3 9	99	18009	float RWES
<b>S.hi</b> , [ S.hi]	<i>Output Process (3)</i> <b>Scale High</b> Set the scale high for process output in electrical units. This value; in volts or milliamps, will correspond to range high value.	-100.0 to 100.0	10.00	<b>Instance 3</b> <i>Map 1</i> <i>Map 2</i> 818 938	0x76 (118) 3 0xA (10)	100	18010	float RWES
<b>r.Lo</b> [ r.Lo]	<i>Output Process (3)</i> <b>Range Low</b> Set the minimum value of the retransmit value range in process units. When the retransmit source is at this value, the retransmit output will be at its Scale Low value.	-1,999.000 to 9,999.000°F or units -1,128.000 to 5,537.000°C	0.0°F or units -18°C	<b>Instance 3</b> <i>Map 1</i> <i>Map 2</i> 820 940	0x76 (118) 3 0xB (11)	101	18011	float RWES
<b>r.hi</b> , [ r.hi]	<i>Output Process (3)</i> <b>Range High</b> Set the maximum value of the retransmit value range in process units. When the retransmit source is at this value, the retransmit output will be at its Scale High value.	100°F or units 38°C	100.0°F or units 38.0°C	<b>Instance 3</b> <i>Map 1</i> <i>Map 2</i> 822 942	0x76 (118) 3 0xC (12)	102	18012	float RWES
<b>o.CA</b> [ o.CA]	<i>Output Process (3)</i> <b>Calibration Offset</b> Set an offset value for a process output.	-1,999.000 to 9,999.000°F or units -1,110.555 to 5,555.000°C	0.0°F or units 0.0°C	<b>Instance 1</b> <i>Map 1</i> <i>Map 2</i> 732 852	0x76 (118) 3 7	105	18007	float RWES
<b>Note:</b> Some values will be rounded off to fit in the four-character display. Full values can be read with other interfaces.  * These parameters/prompts are available in this menu with firmware revisions 11.0 and above.								R: Read W: Write E: EEPROM S: User Set

Setup Page

Display	Parameter Name Description	Range	Default	Modbus Relative Address	CIP Class Instance Attribute hex (dec)	Pro- fibus Index	Param- eter ID	Data Type & Read/ Write
<b>RLP7</b> <b>SEt</b> <b>Alarm Menu</b>								
<b>RLY</b> [A.ty]	<b>Alarm (1 to 4)</b> <b>Alarm Type</b> Select whether the alarm trigger is a fixed value or will track the set point.	<b>oFF</b> Off (62) <b>PrAL</b> Process Alarm (76)	Off	<b>Instance 1</b> <i>Map 1</i> 1508 <i>Map 2</i> 1908	0x6D (109) 1 to 4 0xF (15)	20	9015	uint RWES
<b>SrA</b> [Sr.A]	<b>Alarm (1 to 4)</b> <b>Alarm Source</b> Select what will trigger this alarm.	<b>A</b> Analog Input (142)	----	<b>Instance 1</b> <i>Map 1</i> 1512 <i>Map 2</i> 1912	0x6D (109) 1 to 4 0x11 (17)	21	9017	uint RWES
<b>RHy</b> [A.hy]	<b>Alarm (1 to 4)</b> <b>Alarm Hysteresis</b> Set the hysteresis for an alarm. This determines how far into the safe region the process value needs to move before the alarm can be cleared.	0.001 to 9,999.000°F or units 0.001 to 5,555.000°C	1.0°F or units 1.0°C	<b>Instance 1</b> <i>Map 1</i> 1484 <i>Map 2</i> 1884	0x6D (109) 1 to 4 3	24	9003	float RWES
<b>RL9</b> [A.Lg]	<b>Alarm (1 to 4)</b> <b>Alarm Logic</b> Select what the output condition will be during the alarm state.	<b>RLC</b> Close On Alarm (17) <b>RLo</b> Open On Alarm (66)	Close On Alarm	<b>Instance 1</b> <i>Map 1</i> 1488 <i>Map 2</i> 1888	0x6D (109) 1 to 4 5	25	9005	uint RWES
<b>RSd</b> [A.Sd]	<b>Alarm (1 to 4)</b> <b>Alarm Sides</b> Select which side or sides will trigger this alarm.	<b>both</b> Both (13) <b>h,9h</b> High (37) <b>LoLu</b> Low (53)	Both	<b>Instance 1</b> <i>Map 1</i> 1486 <i>Map 2</i> 1886	0x6D (109) 1 to 4 4	26	9004	uint RWES
<b>Note:</b> Some values will be rounded off to fit in the four-character display. Full values can be read with other interfaces.  * These parameters/prompts are available in this menu with firmware revisions 11.0 and above.								<b>R:</b> Read <b>W:</b> Write <b>E:</b> EEPROM <b>S:</b> User Set

Setup Page

Display	Parameter Name Description	Range	Default	Modbus Relative Address	CIP Class Instance Attribute hex (dec)	Pro- fibus Index	Param- eter ID	Data Type & Read/ Write
<input type="checkbox"/> <b>ALo</b> [ A.Lo]	<i>Alarm (1 to 4)</i> <b>Alarm Low Set Point</b> * If Alarm Type (Setup Page, Alarm Menu) is set to: <b>process</b> - set the process value that will trigger a low alarm.	-1,999.000 to 9,999.000°F or units -1,128.000 to 5,537.000°C	32.0°F or units 0.0°C	<b>Instance 1</b> <i>Map 1 Map 2</i> 1482 1882  Offset to next instance ( <i>Map 1</i> ) equals +50  Offset to next instance ( <i>Map 2</i> ) equals +60	0x6D (109) 1 to 4 2	18	9002	float RWES
<input type="checkbox"/> <b>Ah</b> [ A.hi]	<i>Alarm (1 to 4)</i> <b>Alarm High Set Point</b> * If Alarm Type (Setup Page, Alarm Menu) is set to: <b>process</b> - set the process value that will trigger a high alarm.	-1,999.000 to 9,999.000°F or units -1,128.000 to 5,537.000°C	300.0°F or units 150.0°C	<b>Instance 1</b> <i>Map 1 Map 2</i> 1480 1880  Offset to next instance ( <i>Map 1</i> ) equals +50  Offset to next instance ( <i>Map 2</i> ) equals +60	0x6D (109) 1 to 4 1	19	9001	float RWES
<input type="checkbox"/> <b>ALA</b> [ A.LA]	<i>Alarm (1 to 4)</i> <b>Alarm Latching</b> Turn alarm latching on or off. A latched alarm has to be turned off by the user.	<input type="checkbox"/> <b>nlAL</b> Non-Latching (60) <input type="checkbox"/> <b>lAL</b> Latching (49)	Non-Latching	<b>Instance 1</b> <i>Map 1 Map 2</i> 1492 1892  Offset to next instance ( <i>Map 1</i> equals +50, for <i>Map 2</i> equals +60)	0x6D (109) 1 to 4 7	27	9007	uint RWES
<input type="checkbox"/> <b>AbL</b> [ A.bL]	<i>Alarm (1 to 4)</i> <b>Alarm Blocking</b> Select when an alarm will be blocked. After startup and/or after the set point changes, the alarm will be blocked until the process value enters the normal range.	<input type="checkbox"/> <b>oFF</b> Off (62) <input type="checkbox"/> <b>SEr</b> Startup (88) <input type="checkbox"/> <b>SEPe</b> Set Point (85) <input type="checkbox"/> <b>boTh</b> Both (13)	Off	<b>Instance 1</b> <i>Map 1 Map 2</i> 1494 1894  Offset to next instance ( <i>Map 1</i> equals +50, for <i>Map 2</i> equals +60)	0x6D (109) 1 to 4 8	28	9008	uint RWES
<input type="checkbox"/> <b>AS</b> [ A.Si]	<i>Alarm (1 to 4)</i> <b>Alarm Silencing</b> Turn alarm silencing on to allow the user to disable this alarm.	<input type="checkbox"/> <b>oFF</b> Off (62) <input type="checkbox"/> <b>on</b> On (63)	Off	<b>Instance 1</b> <i>Map 1 Map 2</i> 1490 1890  Offset to next instance ( <i>Map 1</i> equals +50, for <i>Map 2</i> equals +60)	0x6D (109) 1 to 4 6	29	9006	uint RWES
<b>Note:</b> Some values will be rounded off to fit in the four-character display. Full values can be read with other interfaces.  * These parameters/prompts are available in this menu with firmware revisions 11.0 and above.								R: Read W: Write E: EEPROM S: User Set

Setup Page

Display	Parameter Name Description	Range	Default	Modbus Relative Address	CIP Class Instance Attribute hex (dec)	Pro-fibus Index	Parameter ID	Data Type & Read/Write
<b>[A.dSP]</b> [A.dSP]	<i>Alarm (1 to 4)</i> <b>Alarm Display</b> Display an alarm message when an alarm is active.	<input type="checkbox"/> <b>oFF</b> Off (62) <input type="checkbox"/> <b>oN</b> On (63)	On	<b>Instance 1</b> <i>Map 1 Map 2</i> 1510 1910  Offset to next instance ( <i>Map 1 equals +50, for Map 2 equals +60</i> )	0x6D (109) 1 to 4 0x10 (16)	30	9016	uint RWES
<b>[A.dL]</b> [A.dL]	<i>Alarm (1 to 4)</i> <b>Alarm Delay Time</b> Set the span of time that the alarm will be delayed after the process value exceeds the alarm set point.	0 to 9,999 seconds	0	<b>Instance 1</b> <i>Map 1 Map 2</i> 1520 1920  Offset to next instance ( <i>Map 1 equals +50, for Map 2 equals +60</i> )	0x6D (109) 1 to 4 0x15 (21)	31	9021	uint RWES
<b>[A.Clr]</b> [A.Clr]	<i>Alarm (1 to 4)</i> <b>Alarm Clear Request *</b> Write to this register to clear an alarm  <b>Note:</b> If an alarm is setup to latch when active <b>[A.Clr]</b> will appear on the display.	<input type="checkbox"/> <b>CLr</b> Clear (0) <input type="checkbox"/> <b>Ignr</b> Ignore (204)	----	<b>Instance 1</b> <i>Map 1 Map 2</i> 1504 1904  Offset to next instance ( <i>Map1 1 equals +50, Map 2 equals +60</i> )	0x6D (109) 1 to 4 0xD (13)	----	9013	uint W
<b>[A.Sir]</b> [A.Sir]	<i>Alarm (1 to 4)</i> <b>Alarm Silence Request *</b> Write to this register to silence an alarm  <b>Note:</b> If an alarm is setup to silence alarm when active <b>[A.Sir]</b> will appear on the display.	<input type="checkbox"/> <b>SIL</b> Silence (1010)	0	<b>Instance 1</b> <i>Map 1 Map 2</i> 1506 1906  Offset to next instance ( <i>Map1 1 equals +50, Map 2 equals +60</i> )	0x6D (109) 1 to 4 0xE (14)	----	9014	uint W
<b>[A.St]</b> [A.St]	<i>Alarm (1 to 4)</i> <b>Alarm State *</b> Current state of alarm	<input type="checkbox"/> <b>Str</b> Startup (88) <input type="checkbox"/> <b>nonE</b> None (61) <input type="checkbox"/> <b>blo</b> Blocked (12) <input type="checkbox"/> <b>ALl</b> Alarm low (8) <input type="checkbox"/> <b>ALh</b> Alarm high (7) <input type="checkbox"/> <b>Err</b> Error (28)	----	<b>Instance 1</b> <i>Map 1 Map 2</i> 1496 1896  Offset to next instance ( <i>Map1 1 equals +50, Map 2 equals +60</i> )	0x6D (109) 1 to 4 9	----	9009	uint R
<b>Note:</b> Some values will be rounded off to fit in the four-character display. Full values can be read with other interfaces.  * These parameters/prompts are available in this menu with firmware revisions 11.0 and above.								R: Read W: Write E: EEPROM S: User Set

Setup Page

Display	Parameter Name Description	Range	Default	Modbus Relative Address	CIP Class Instance Attribute hex (dec)	Pro-fibus Index	Parameter ID	Data Type & Read/Write
<b>Function Key</b> <input type="checkbox"/> <b>Fun</b> <input type="checkbox"/> <b>Set</b>								
<input type="checkbox"/> <b>LEu</b> [ LEv]	<b>Function Key (3 to 4)</b> <b>Active Level</b> Selects the state in which the Action Function will be active. Pressing the Function Key will toggle the selected action.	<input type="checkbox"/> <b>H9H</b> High (37) <input type="checkbox"/> <b>L0L0</b> Low (53)	High	<b>Instance 3</b> Map 1 Map 2 1360 1600 <b>Instance 4</b> Map 1 Map 2 1380 1620	0x6E (110) 3 to 4 1	137	10001	uint RWES
<input type="checkbox"/> <b>Fn</b> [ Fn]	<b>Function Key (1 to 2)</b> <b>Action Function</b> Program the EZ Key to trigger an action. Functions respond to a level state change or an edge level change.  <b>Note:</b> The Limit Reset function is not available in firmware revision 11.0 and above.	<input type="checkbox"/> <b>none</b> None <input type="checkbox"/> <b>LrTr</b> Limit Reset, edge triggered (82) <input type="checkbox"/> <b>FAL</b> Force Alarm To Occur, level triggered (218) <input type="checkbox"/> <b>RoF</b> Control Loops Off and Alarms to Non-alarm State, level triggered (220) <input type="checkbox"/> <b>SIL</b> Silence Alarms, edge triggered (108) <input type="checkbox"/> <b>ALrTr</b> Alarm Reset, edge triggered (6) <input type="checkbox"/> <b>PLoC</b> Keypad Lockout, level triggered (217) <input type="checkbox"/> <b>uSrr</b> User Set Restore, edge triggered (227)	None	<b>Instance 1</b> Map 1 Map 2 1364 1604 <b>Instance 2</b> Map 1 Map 2 1384 1624	0x6E (110) 1 to 2 3	138	10003	uint RWES
<input type="checkbox"/> <b>Fi</b> [ Fi]	<b>Function Key (1 to 2)</b> <b>Function Instance</b> Select which instance the EZ Key will affect. If only one instance is available, any selection will affect it.	1 to 4	0	<b>Instance 1</b> Map 1 Map 2 1364 1606 <b>Instance 2</b> Map 1 Map 2 1384 1626	0x96 (110) 1 to 2 4	139	10004	----
<b>Global Menu</b> <input type="checkbox"/> <b>GLbL</b> <input type="checkbox"/> <b>SEE</b>								
<input type="checkbox"/> <b>C.F</b> [ C.F]	<b>Global Display Units</b> Select which scale to use for temperature.	<input type="checkbox"/> <b>F</b> °F (30) <input type="checkbox"/> <b>C</b> °C (15)	°F	----	0x67 (103) 1 5	110	3005	uint RWES
<input type="checkbox"/> <b>AC.LF</b> [AC.LF]	<b>Global AC Line Frequency</b> Set the frequency to the applied ac line power source.	<input type="checkbox"/> <b>50</b> 50 Hz (3) <input type="checkbox"/> <b>60</b> 60 Hz (4)	60 Hz	<b>Instance 1</b> Map 1 Map 2 886 1006	0x6A (106) 1 4	89	1034	uint RWES
<input type="checkbox"/> <b>C.LEd</b> [C.LEd]	<b>Global Communications LED Action</b> Turns comms LED on or off for selected comms ports.	<input type="checkbox"/> <b>Con1</b> Comm port 1 (1189) <input type="checkbox"/> <b>Con2</b> Comm port 2 (1190) <input type="checkbox"/> <b>both</b> Comm port 1 and 2 (13) <input type="checkbox"/> <b>oFF</b> Off (62)	both	<b>Instance 1</b> Map 1 Map 2 1856 2326	0x6A (103) 1 0x0E (14)	----	3014	uint RWES
<b>Note:</b> Some values will be rounded off to fit in the four-character display. Full values can be read with other interfaces.  * These parameters/prompts are available in this menu with firmware revisions 11.0 and above.								R: Read W: Write E: EEPROM S: User Set

Setup Page

Display	Parameter Name Description	Range	Default	Modbus Relative Address	CIP Class Instance Attribute hex (dec)	Pro-fibus Index	Parameter ID	Data Type & Read/Write
<b>[Zone]</b> [Zone]	<i>Global</i> <b>Zone</b> Turns Zone LED on or off based on selection.	<b>OFF</b> Off (62) <b>ON</b> On (63)	On	<b>Instance 1</b> Map 1 Map 2 ---- 2350	0x6A (103) 1 0x1A (26)	----	3026	uint RWES
<b>[Chan]</b> [Chan]	<i>Global</i> <b>Channel</b> Turns Channel LED on or off based on selection.	<b>OFF</b> Off (62) <b>ON</b> On (63)	On	<b>Instance 1</b> Map 1 Map 2 ---- 2352	0x6A (103) 1 0x1B (27)	----	3027	uint RWES
<b>[dPrS]</b> [dPrS]	<i>Global</i> <b>Display Pairs</b> Defines the number of Display Pairs.	1 to 10	2	<b>Instance 1</b> Map 1 Map 2 ---- 2354	0x6A (103) 1 0x1C (28)	----	3028	uint RWES
<b>[d.ti]</b> [ d.ti]	<i>Global</i> <b>Display Time</b> Time delay in toggling between Display Pairs.	0 to 60	0	<b>Instance 1</b> Map 1 Map 2 ---- 2356	0x6A (103) 1 0x1D (29)	----	3029	uint RWES
<b>[USr.S]</b> [USr.S]	<i>Global</i> <b>User Settings Save</b> Save all of this controller's settings to the selected set.	<b>SET 1</b> User Set 1 (101) <b>SET 2</b> User Set 2 (102) <b>none</b> None (61)	None	<b>Instance 1</b> Map 1 Map 2 26 26	0x(101) 1 0xE (14)	118	1014	uint RWE
<b>[USr.r]</b> [USr.r]	<i>Global</i> <b>User Settings Restore</b> Replace all of this controller's settings with another set.	<b>FACTY</b> Factory (31) <b>none</b> None (61) <b>SET 1</b> User Set 1 (101) <b>SET 2</b> User Set 2 (102)	None	<b>Instance 1</b> Map 1 Map 2 24 24	0x65 (101) 1 0xD (13)	117	1013	uint RWE
<b>[COMM]</b> <b>[SET]</b> <b>Communications Menu</b>								
<b>[PCoL]</b> [PCoL]	<i>Communications 1</i> <b>Protocol</b> Set the protocol of this controller to the protocol that this network is using.	<b>Std</b> Standard Bus (1286) <b>RTUod</b> Modbus RTU (1057)	Modbus	<b>Instance 1</b> Map 1 Map 2 2492 2972	0x96 (150) 1 7	----	17009	uint RWE
<b>[Ad.S]</b> [ Ad.S]	<i>Communications 1</i> <b>Standard Bus Address</b> Set the network address of this controller. Each device on the network must have a unique address. The Zone Display on the front panel will display this number.	1 to 16	1	<b>Instance 1</b> Map 1 Map 2 2480 2960	0x96 (150) 1 1	----	17001	uint RWE
<b>[Ad.M]</b> [Ad.M]	<i>Communications (1 or 2)</i> <b>Modbus Address</b> Set the network address of this controller. Each device on the network must have a unique address.	1 to 247	1	<b>Instance 1</b> Map 1 Map 2 2482 2962 <b>Instance 2</b> Map 1 Map 2 2500 2980	0x96 (150) 1 2	----	17007	uint RWE
<b>Note:</b> Some values will be rounded off to fit in the four-character display. Full values can be read with other interfaces.  * These parameters/prompts are available in this menu with firmware revisions 11.0 and above.								R: Read W: Write E: EEPROM S: User Set

Setup Page

Display	Parameter Name Description	Range	Default	Modbus Relative Address	CIP Class Instance Attribute hex (dec)	Pro- fibus Index	Param- eter ID	Data Type & Read/ Write
<input type="checkbox"/> BAUD [bAUd]	<i>Communications (1 or 2)</i> <b>Baud Rate</b> Set the speed of this controller's communications to match the speed of the Modbus serial network.	<input type="text" value="9600"/> 9,600 (188) <input type="text" value="192"/> 19,200 (189) <input type="text" value="384"/> 38,400 (190)	9,600	<b>Instance 1</b> <i>Map 1</i> <i>Map 2</i> 2484 2964 <b>Instance 2</b> <i>Map 1</i> <i>Map 2</i> 2504 2984	0x96 (150) 1 3	----	17002	uint RWE
<input type="checkbox"/> PAR [PAr]	<i>Communications (1 or 2)</i> <b>Parity</b> Set the parity of this controller to match the parity of the Modbus serial network.	<input type="checkbox"/> none None <input type="checkbox"/> Even Even <input type="checkbox"/> odd Odd	None	<b>Instance 1</b> <i>Map 1</i> <i>Map 2</i> 2486 2966 <b>Instance 2</b> <i>Map 1</i> <i>Map 2</i> 2506 2986	0x96 (150) 1 4	----	17003	uint RWE
<input type="checkbox"/> C_F [C_F]	<i>Communications (1)</i> <b>Display Units</b> Select whether this communications channel will display in Celsius or Fahrenheit.  <b>Note:</b> Applies to Modbus only.	<input type="checkbox"/> F Fahrenheit (30) <input type="checkbox"/> C Celsius (15)	F	<b>Instance 1</b> <i>Map 1</i> <i>Map 2</i> 2490 2970	0x96 (150) 1 6	----	17050	uint RWE
<input type="checkbox"/> M.hL [M.hL]	<i>Communications (1 or 2)</i> <b>Modbus Word Order</b> Select the word order of the two 16-bit words in the floating-point values.	<input type="checkbox"/> Loh Low-High <input type="checkbox"/> hLo High-Low	Low-High	<b>Instance 1</b> <i>Map 1</i> <i>Map 2</i> 2488 2968 <b>Instance 2</b> <i>Map 1</i> <i>Map 2</i> 2508 2988	0x96 (150) 1 5	----	17043	uint RWE
<input type="checkbox"/> MAP [Map]	<i>Communications (1)</i> <b>Data Map</b> If set to 1 the control will use PM legacy mapping. If set to 2 the control will use new mapping to accommodate new functions.	1 to 2	1 if 9 <sup>th</sup> digit of part number is a 1 otherwise, 2	----	----	----	17059	uint RWE
<input type="checkbox"/> nVS [nV.S]	<i>Communications (1)</i> <b>Non-Volatile Save</b> If set to Yes all values written to the control will be saved in EEPROM. The EEPROM allows for approximately one million writes.	<input type="checkbox"/> YES Yes (106) <input type="checkbox"/> no No (59)	Yes	<b>Instance 1</b> <i>Map 1</i> <i>Map 2</i> 2494 2974	0x96 (150) 1 8	198	17051	uint RWE
<input type="checkbox"/> Ad.d [Ad.d]	<i>Communications (2)</i> <b>DeviceNet™ Node Address</b> Set the DeviceNet™ address for this gateway.	0 to 63	63	----	----	----	17052	----
<b>Note:</b> Some values will be rounded off to fit in the four-character display. Full values can be read with other interfaces.  * These parameters/prompts are available in this menu with firmware revisions 11.0 and above.								R: Read W: Write E: EEPROM S: User Set

Setup Page

Display	Parameter Name Description	Range	Default	Modbus Relative Address	CIP Class Instance Attribute hex (dec)	Profibus Index	Parameter ID	Data Type & Read/Write
<b>[bAUD]</b> [bAUd]	<i>Communications (2)</i> <b>Baud Rate DeviceNet™</b> Set the speed of this gateway's communications to match the speed of the serial network.	<input type="checkbox"/> <b>125</b> 125 kb <input type="checkbox"/> <b>250</b> 250 kb <input type="checkbox"/> <b>500</b> 500 kb	125	----	----	----	17053	----
<input type="checkbox"/> <b>[FC.E]</b> [FC.E]	<i>Communications (2)</i> <b>DeviceNet™ Quick Connect Enable</b> Allows for immediate communication with the scanner upon power up.	<input type="checkbox"/> <b>no</b> No <input type="checkbox"/> <b>YES</b> Yes	No	----	----	----	17054	----
<b>[PAdd]</b> [P.Add]	<i>Communications (2)</i> <b>Profibus Node Address</b> Set the Profibus address for this control.	0 to 126	126	----	----	----	17060	----
<b>[ALoc]</b> [A.Loc]	<i>Communications (2)</i> <b>Profibus Address Lock</b> Set the DeviceNet™ address for this gateway.	<input type="checkbox"/> <b>no</b> No (59) <input type="checkbox"/> <b>YES</b> Yes (106)	No	----	----	----	17061	----
<input type="checkbox"/> <b>[iPM]</b> [iP.M]	<i>Communications (2)</i> <b>IP Address Mode</b> Select DHCP to let a DHCP server assign an address to this module.	<input type="checkbox"/> <b>dhCP</b> DHCP (1281) <input type="checkbox"/> <b>FAdd</b> Fixed Address (1284)	DHCP	----	----	----	17012	----
<input type="checkbox"/> <b>[ip.F1]</b> [ip.F1]	<i>Communications (2)</i> <b>IP Fixed Address Part 1</b> Set the IP address of this module. Each device on the network must have a unique address.	0 to 255	169	----	----	----	17014	----
<input type="checkbox"/> <b>[ip.F2]</b> [ip.F2]	<i>Communications (2)</i> <b>IP Fixed Address Part 2</b> Set the IP address of this module. Each device on the network must have a unique address.	0 to 255	254	----	----	----	17015	----
<input type="checkbox"/> <b>[ip.F3]</b> [ip.F3]	<i>Communications (2)</i> <b>IP Fixed Address Part 3</b> Set the IP address of this module. Each device on the network must have a unique address.	0 to 255	1	----	----	----	17016	----
<b>Note:</b> Some values will be rounded off to fit in the four-character display. Full values can be read with other interfaces.  * These parameters/prompts are available in this menu with firmware revisions 11.0 and above.								R: Read W: Write E: EEPROM S: User Set



Setup Page

Display	Parameter Name Description	Range	Default	Modbus Relative Address	CIP Class Instance Attribute hex (dec)	Pro- fibus Index	Param- eter ID	Data Type & Read/ Write
[PF4] [ip.F4]	<i>Communications (2)</i> <b>IP Fixed Address Part 4</b> Set the IP address of this module. Each device on the network must have a unique address.	0 to 255	1	----	----	----	17017	----
[PF5] [ip.F5]	<i>Communications (2)</i> <b>IP Fixed Address Part 5</b> Set the IP address of this module. Each device on the network must have a unique address.	0 to 255	0	----	----	----	17018	----
[PF6] [ip.F6]	<i>Communications (2)</i> <b>IP Fixed Address Part 6</b> Set the IP address of this module. Each device on the network must have a unique address.	0 to 255	0	----	----	----	17019	----
[P51] [ip.S1]	<i>Communications (2)</i> <b>IP Fixed Subnet Part 1</b> Set the IP subnet mask for this module.	0 to 255	255	----	----	----	17020	----
[P52] [ip.S2]	<i>Communications (2)</i> <b>IP Fixed Subnet Part 2</b> Set the IP subnet mask for this module.	0 to 255	255	----	----	----	17021	----
[P53] [ip.S3]	<i>Communications (2)</i> <b>IP Fixed Subnet Part 3</b> Set the IP subnet mask for this module.	0 to 255	0	----	----	----	17022	----
[P54] [ip.S4]	<i>Communications (2)</i> <b>IP Fixed Subnet Part 4</b> Set the IP subnet mask for this module.	0 to 255	0	----	----	----	17023	----
[P55] [ip.S5]	<i>Communications (2)</i> <b>IP Fixed Subnet Part 5</b> Set the IP subnet mask for this module.	0 to 255	0	----	----	----	17024	----
[P56] [ip.S6]	<i>Communications (2)</i> <b>IP Fixed Subnet Part 6</b> Set the IP subnet mask for this module.	0 to 255	0	----	----	----	17025	----
<b>Note:</b> Some values will be rounded off to fit in the four-character display. Full values can be read with other interfaces.  * These parameters/prompts are available in this menu with firmware revisions 11.0 and above.								R: Read W: Write E: EEPROM S: User Set

Setup Page

Display	Parameter Name Description	Range	Default	Modbus Relative Address	CIP Class Instance Attribute hex (dec)	Pro-fibus Index	Parameter ID	Data Type & Read/Write
<input type="checkbox"/> .P.91 [ip.g1]	Communications (2) <b>Fixed IP Gateway Part 1</b>	0 to 255	0	----	----	----	17026	----
<input type="checkbox"/> .P.92 [ip.g2]	Communications (2) <b>Fixed IP Gateway Part 2</b>	0 to 255	0	----	----	----	17027	----
<input type="checkbox"/> .P.93 [ip.g3]	Communications (2) <b>Fixed IP Gateway Part 3</b>	0 to 255	0	----	----	----	17028	----
<input type="checkbox"/> .P.94 [ip.g4]	Communications (2) <b>Fixed IP Gateway Part 4</b>	0 to 255	0	----	----	----	17029	----
<input type="checkbox"/> .P.95 [ip.g5]	Communications (2) <b>Fixed IP Gateway Part 5</b>	0 to 255	0	----	----	----	17030	----
<input type="checkbox"/> .P.96 [ip.g6]	Communications (2) <b>Fixed IP Gateway Part 6</b>	0 to 255	0	----	----	----	17031	----
<input type="checkbox"/> Mb.E [Mb.E]	Communications (2) <b>Modbus TCP Enable</b> Activate Modbus TCP.	<input type="checkbox"/> YES Yes <input type="checkbox"/> NO No	Yes	----	----	----	17041	----
<input type="checkbox"/> Ei.P.E [Ei.P.E]	Communications (2) <b>EtherNet/IP™ Enable</b> Activate Ethernet/IP™.	<input type="checkbox"/> YES Yes <input type="checkbox"/> NO No	Yes	----	----	----	17042	----
<input type="checkbox"/> Ao.nb [Ao.nb]	Communications (2) <b>CIP Implicit Assembly Output Member Quantity</b>	1 to 20	20	----	----	----	24009	----
<input type="checkbox"/> Ai.nb [Ai.nb]	Communications (2) <b>CIP Implicit Assembly Input Member Quantity</b>	1 to 20	20	----	----	----	24010	----
<input type="checkbox"/> C.F [C.F]	Communications (2) <b>Display Units</b> Select which scale to use for temperature passed over communications port 2.	<input type="checkbox"/> F °F (30) <input type="checkbox"/> C °C (15)	°F	<b>Instance 2</b> Map 1    Map 2 ----    2990	0x96 (150) 1 6	199	17050	uint RWE
<input type="checkbox"/> Map [Map]	Communications (2) <b>Data Map</b> If set to 1 the control will use PM legacy mapping. If set to 2 the control will use new mapping to accommodate new functions.	1 to 2	1 if 9th digit of part number is a 1 otherwise, 2	----	----	----	17059	----
<b>Note:</b> Some values will be rounded off to fit in the four-character display. Full values can be read with other interfaces.  * These parameters/prompts are available in this menu with firmware revisions 11.0 and above.								R: Read W: Write E: EEPROM S: User Set



### Setup Page





Display	Parameter Name Description	Range	Default	Modbus Relative Address	CIP Class Instance Attribute hex (dec)	Profibus Index	Parameter ID	Data Type & Read/Write
<input type="checkbox"/> <b>nUS</b> [ nU.S]	<i>Communications (2)</i> <b>Non-Volatile Save</b> If set to Yes all values written to the control will be saved in EEPROM. The EEPROM allows for approximately one million writes.	<input type="checkbox"/> <b>YES</b> Yes <input type="checkbox"/> <b>no</b> No	Yes	<b>Instance 2</b> <i>Map 1    Map 2</i> 2514    2994	96 (150) 2 8	198	17051	uint RWE
<b>Note:</b> Some values will be rounded off to fit in the four-character display. Full values can be read with other interfaces.  * These parameters/prompts are available in this menu with firmware revisions 11.0 and above.								R: Read W: Write E: EEPROM S: User Set

# 7

## Chapter 7: Factory Page

### Navigating the Factory Page

To go to the Factory Page from the Home Page, press and hold both the Advance  and Reset  keys for six seconds.

- Press the Advance Key  to move through the parameter prompts.
- Press the Up  or Down  keys to change the parameter value.
- Press the Reset key  to return to the Home Page.

#### Note:

Some of these menus and parameters may not appear, depending on the controller's options. See model number information in the Appendix for more information. If there is only one instance of a menu, no sub-menus will appear.

#### Note:

Some of the listed parameters may not be visible. Parameter visibility is dependent upon controller part number.

```
[CUSE]
[FCEY] Custom Setup Menu
  [ ]
  [CUSE] Custom Setup (1 to 20)
    [PAR] Parameter
    [ ,ID] Instance ID

[L0C]
[FCEY] Security Setting Menu
  [L0C] Security Setting
    [L0C0] Operations Page
    [PASE] Password
    [rL0C] Read Lock
    [SL0C] Write Security
    [L0CL] Locked Access Level
    [r0LL] Rolling Password
    [P5U] User Password
    [P5A] Administrator Password

[UL0C]
[FCEY] Security Setting Menu
  [C0DE] Public Key
  [P55] Password

[d ,R9]
[FCEY] Diagnostics Menu
  [d ,R9] Diagnostics
    [Pn] Part Number
    [rEv] Software Revision
    [S,bLd] Software Build Number
    [Sn] Serial Number
    [dRtE] Date of Manufacture
    [ ,PAC] IP Actual Address Mode
    [ ,PAA1] IP Actual Address Part 1
    [ ,PAA2] IP Actual Address Part 2
    [ ,PAA3] IP Actual Address Part 3
    [ ,PAA4] IP Actual Address Part 4
    [ ,PAA5] IP Actual Address Part 5
    [ ,PAA6] IP Actual Address Part 6
```

```
[CAL]
[FCEY] Calibration Menu
  [ ]
  [CAL] Calibration (1 or 3)
    [P7U] Electrical Measurement
    [EL ,0] Electrical Input Offset
    [EL ,5] Electrical Input Slope
    [EL 0,0] Electrical Output Offset
    [EL ,5] Electrical Output Slope
    [EL 0,5] Electrical Output Slope
    [Pn] Part Number
    [C0dE] Code
```

Factory Page

Display	Parameter Name Description	Range	Default	Modbus Relative Address	CIP Class Instance Attribute hex (dec)	Profibus Index	Parameter ID	Data Type & Read/Write
<b>[USE]</b> <b>[FctY]</b> <b>Custom Menu</b>								
<b>[PRP]</b> [Par]	<i>Custom</i> <b>Parameter 1 to 20</b> Select the parameters that will appear in the Home Page.  The Parameter 1 value will appear in the upper display of the Home Page. It cannot be changed with the Up and Down Keys in the Home Page.  The Parameter 2 value will appear in the lower display in the Home Page. It can be changed with the Up and Down Keys, if the parameter is a writable one.  Scroll through the other Home Page parameters with the Advance Key  .  <b>Note:</b> Display Pairs affect the pairing of custom parameters on the Home page. For more information on Display Pairs see the section in this guide entitled "Modifying the Display Pairs".	<b>[none]</b> None <b>[LSE]</b> Limit State <b>[LHY]</b> Limit Hysteresis <b>[LHS]</b> Limit High Set Point <b>[LLS]</b> Limit Low Set Point <b>[USE]</b> Custom Menu <b>[RHY]</b> Alarm Hysteresis <b>[RHI]</b> Alarm High Set Point <b>[RLO]</b> Alarm Low Set Point <b>[USRR]</b> User Settings Restore <b>[CF]</b> Display Units <b>[CR]</b> Calibration Offset <b>[Pro]</b> Process	See: Home Page	----	----	----	14005	----
<b>[iid]</b> [iid]	<i>Custom (1 to 20)</i> <b>Instance ID</b> Select which instance of the parameter will be selected.	1 to 4	----	----	----	----	14003	----
<b>[LoC]</b> <b>[FctY]</b> <b>Lock Menu</b>								
<b>[LoC.o]</b> [LoC.o]	<i>Security Setting</i> <b>Operations Page</b> Change the security level of the Operations Page.	1 to 3	2	<b>Instance 1</b> <i>Map 1</i> <i>Map 2</i> 1832    2302	0x67 (103) 1 2	----	3002	uint RWE
<b>[PRSE]</b> [LoC.P]	<i>Security Setting</i> <b>Password Enable</b> Set to On to require a password for menu changes.	<b>[OFF]</b> Off <b>[on]</b> On	Off	----	----	----	3009	uint RWE
<b>Note:</b> Some values will be rounded off to fit in the four-character display. Full values can be read with other interfaces.								R: Read W: Write E: EEPROM S: User Set

### Factory Page

Display	Parameter Name Description	Range	Default	Modbus Relative Ad- dress	CIP Class Instance Attribute hex (dec)	Pro- fibus Index	Param- eter ID	Data Type & Read/ Write
<b>rLoC</b> [rLoC]	<i>Security Setting</i> <b>Read Lock</b> Set the read security clearance level. The user can access the selected level and all lower levels. If the Set Lockout Security level is higher than the Read Lockout Security, the Read Lockout Security level takes priority.	1 to 5	5	<b>Instance 1</b> <i>Map 1</i> <i>Map 2</i> 1848   2318	0x67 (103) 1 0x0A (10)	----	3010	uint RWE
<b>SLoC</b> [SLoC]	<i>Security Setting</i> <b>Write Security</b> Set the write security clearance level. The user can access the selected level and all lower levels. If the Set Lockout Security level is higher than the Read Lockout Security, the Read Lockout Security level takes priority.	0 to 5	5	<b>Instance 1</b> <i>Map 1</i> <i>Map 2</i> 1844   2314	0x67 (103) 1 0x0B (11)	----	3011	uint RWE
<b>LoCL</b> [LoC.L]	<i>Security Setting</i> <b>Locked Access Level</b> Determines user level menu visibility when security is enabled. See Features section under Password Security.	1 to 5	5	----	----	----	3016	uint RWE
<b>roLL</b> [roLL]	<i>Security Setting</i> <b>Rolling Password</b> When power is cycled a new Public Key will be displayed and User Password changes.	<input type="checkbox"/> <b>oFF</b> Off <input type="checkbox"/> <b>oN</b> On	Off	----	----	----	3019	uint RWE
<b>PAS.u</b> [PAS.u]	<i>Security Setting</i> <b>User Password</b> Used to acquire access to menus made available through the Locked Access Level setting.	10 to 999	63	----	----	----	3017	uint RWE
<b>PAS.A</b> [PAS.A]	<i>Security Setting</i> <b>Administrator Password</b> Used to acquire full access to all menus including disabling or changing passwords.	10 to 999	156	----	----	----	3018	uint RWE
<b>Note:</b> Some values will be rounded off to fit in the four-character display. Full values can be read with other interfaces.								R: Read W: Write E: EEPROM S: User Set

**Factory Page**

Display	Parameter Name Description	Range	Default	Modbus Relative Address	CIP Class Instance Attribute hex (dec)	Pro-fibus Index	Parameter ID	Data Type & Read/Write
<b>ULoC</b> <b>FCT4</b> <b>Unlock Menu</b>								
<b>CodE</b> [CodE]	<i>Security Setting</i> <b>Public Key</b> If Rolling Password turned on, generates a random number when power is cycled. If Rolling Password is off fixed number will be displayed. The key can be used to gain access when the password is not known.	Customer Specific	0	----	----	----	3020	uint R
<b>PASS</b> [PASS]	<i>Security Setting</i> <b>Password</b> Enter the User or Administrator password to gain access. Exit this menu and reenter Factory Page, Security menu after valid password is supplied.	-1999 to 9999	0	----	----	----	3022	int RW
<b>d.r9</b> <b>FCT4</b> <b>Diagnostic Menu</b>								
<b>Pn</b> [ Pn]	<i>Diagnostics</i> <b>Part Number</b> Display this controller's part number.	15 characters	----	----	0x65 (101) 1 9	115	1009	string RWE
<b>rEu</b> [ rEu]	<i>Diagnostics</i> <b>Software Revision</b> Display this controller's firmware revision number.	1 to 10	----	----	0x65 (101) 1 0x11 (17)	116	1003	string R
<b>SbLd</b> [S.bLd]	<i>Diagnostics</i> <b>Software Build Number</b> Display the firmware build number.	0 to 2,147,483,647	----	<b>Instance 1</b> <i>Map 1    Map 2</i> 8            8	0x65 (101) 1 5	----	1005	dint R
<b>Sn</b> [ Sn]	<i>Diagnostics</i> <b>Serial Number</b> Display the serial number.	0 to 2,147,483,647	----	----	0x65 (101) 1 0x20 (32)	----	1032	string RWE
<b>dAtE</b> [dAtE]	<i>Diagnostics</i> <b>Date of Manufacture</b> Display the date code (YYWW). Where YY = year and WW= week..	0 to 2,147,483,647	----	<b>Instance 1</b> <i>Map 1    Map 2</i> 14        14	0x65 (101) 1 8	----	1008	dint RWE
<b>iPAC</b> [iP.AC]	<i>Diagnostics</i> <b>IP Address Mode</b> Actual address mode (DHCP or Fixed).	<b>dhCP</b> DHCP (1281) <b>FAdd</b> Fixed Address (1284)	DHCP	----	----	----	17013	----
<b>Note:</b> Some values will be rounded off to fit in the four-character display. Full values can be read with other interfaces.								R: Read W: Write E: EEPROM S: User Set

Factory Page

Display	Parameter Name Description	Range	Default	Modbus Relative Ad- dress	CIP Class Instance Attribute hex (dec)	Pro- fibus Index	Param- eter ID	Data Type & Read/ Write
<b>.P.A1</b> [ip.F1]	<i>Diagnostics</i> <b>IP Actual Address Part 1</b> Actual IP address of this module. Each device on the network must have a unique address.	0 to 255	169	----	----	----	17014	----
<b>.P.A2</b> [ip.F2]	<i>Diagnostics</i> <b>IP Actual Address Part 2</b> Actual IP address of this module. Each device on the network must have a unique address.	0 to 255	254	----	----	----	17015	----
<b>.P.A3</b> [ip.F3]	<i>Diagnostics</i> <b>IP Actual Address Part 3</b> Actual IP address of this module. Each device on the network must have a unique address.	0 to 255	1	----	----	----	17016	----
<b>.P.A4</b> [ip.F4]	<i>Diagnostics</i> <b>IP Actual Address Part 4</b> Actual IP address of this module. Each device on the network must have a unique address.	0 to 255	1	----	----	----	17017	----
<b>.P.A5</b> [ip.F5]	<i>Diagnostics</i> <b>IP Actual Address Part 5</b> Actual IP address of this module. Each device on the network must have a unique address.	0 to 255	1	----	----	----	17018	----
<b>.P.A6</b> [ip.F6]	<i>Diagnostics</i> <b>IP Actual Address Part 6</b> Actual IP address of this module. Each device on the network must have a unique address.	0 to 255	1	----	----	----	17019	----
<b>.CAL</b> <b>.FEY</b> <b>Calibration Menu</b>								
<b>.M.V</b> [ Mv]	<i>Calibration (1)</i> <b>Electrical Measure- ment</b> Read the raw electrical value for this input in the units corresponding to the Sensor Type (Setup Page, Analog Input Menu) setting.	-3.4e38 to 3.4e38	0.0	<b>Instance 1</b> <i>Map 1</i> <i>Map 2</i> 400        400	0x68 (104) 1 0x15 (21)	----	4021	float R
<b>Note:</b> Some values will be rounded off to fit in the four-character display. Full values can be read with other interfaces.								R: Read W: Write E: EEPROM S: User Set



Factory Page

Display	Parameter Name Description	Range	Default	Modbus Relative Address	CIP Class Instance Attribute hex (dec)	Pro-fibus Index	Parameter ID	Data Type & Read/Write
<b>[EL.o]</b> [ELi.o]	<i>Calibration (1)</i> <b>Electrical Input Offset</b> Change this value to calibrate the low end of the input range.	-1,999.000 to 9,999.000	0.0	<b>Instance 1</b> <i>Map 1</i> <i>Map 2</i> 378        378	0x68 (104) 1 0xA (10)	----	4010	float RWES
<b>[EL.S]</b> [ELi.S]	<i>Calibration (1)</i> <b>Electrical Input Slope</b> Adjust this value to calibrate the slope of the input value.	-1,999.000 to 9,999.000	1.0	<b>Instance 1</b> <i>Map 1</i> <i>Map 2</i> 380        380	0x68 (104) 1 0xB (11)	----	4011	float RWES
<b>[EL.o]</b> [ELo.o]	<i>Calibration (3)</i> <b>Electrical Output Offset</b> Change this value to calibrate the low end of the output range. Menu 2 calibrates output 3.	-1,999.000 to 9,999.000	0.0	<b>Instance 1</b> <i>Map 1</i> <i>Map 2</i> 808        928	0x76 (118) 3 5	----	18005	float RWES
<b>[EL.S]</b> [ELo.S]	<i>Calibration (3)</i> <b>Electrical Output Slope</b> Adjust this value to calibrate the slope of the output value. Menu 2 calibrates output 3.	-1,999.000 to 9,999.000	1.0	<b>Instance 1</b> <i>Map 1</i> <i>Map 2</i> 730        850	0x76 (118) 3 6	----	18006	float RWES
<b>[Pn]</b> [ Pn]	<i>Calibration (1 to 2)</i> <b>Part Number</b> Displays current setting for control model number.	<b>[FctY]</b> Factory <b>[USEr]</b> User	Factory	----	----	----	----	uint R
<b>[CodE]</b> [CodE]	<i>Calibration (1 to 3)</i> <b>Public Key</b> Changes the control to a PM Express or back to original model number as shown on the side of the control.	<b>[2501]</b> PM Express <b>[606]</b> Factory model number	4999	----	----	----	----	uint RWE
<b>Note:</b> Some values will be rounded off to fit in the four-character display. Full values can be read with other interfaces.								R: Read W: Write E: EEPROM S: User Set

# 8

## Chapter 8: Features

<b>Changing PM Limit Model Number to PM Express Limit</b> . . . . .	<b>72</b>
How to Change the Control Model Number to a PM Express . . . . .	72
How to Restore Original PM Model Number . . . . .	73
<b>Saving and Restoring User Settings</b> . . . . .	<b>73</b>
<b>Programming the Home Page</b> . . . . .	<b>73</b>
<b>Inputs</b> . . . . .	<b>73</b>
Calibration Offset . . . . .	73
Calibration . . . . .	74
Filter Time Constant . . . . .	75
Sensor Selection . . . . .	75
Set Point Low Limit and High Limit . . . . .	75
Scale High and Scale Low . . . . .	76
Range High and Range Low . . . . .	76
<b>Outputs</b> . . . . .	<b>76</b>
Retransmitting a Process Value or Set Point . . . . .	76
<b>Resetting a Tripped Limit</b> . . . . .	<b>77</b>
<b>Alarms</b> . . . . .	<b>77</b>
Process Alarms . . . . .	77
Alarm Set Points . . . . .	77
Alarm Hysteresis . . . . .	78
Alarm Latching . . . . .	78
Alarm Silencing . . . . .	78
Alarm Blocking . . . . .	78
<b>Using Lockout and Password Security</b> . . . . .	<b>79</b>
<b>Modbus - Using Programmable Memory Blocks</b> . . . . .	<b>81</b>
<b>CIP - Communications Capabilities</b> . . . . .	<b>82</b>
<b>Profibus DP - (Decentralized Peripherals)</b> . . . . .	<b>83</b>
<b>Software Configuration</b> . . . . .	<b>84</b>

# Changing PM Limit Model Number to PM Express Limit

EZ-ZONE PM Limit firmware revisions of 13 and above allow the user to switch between a PM Limit control to a PM Express Limit. Switching to a PM Express Limit eliminates the complexity of the PM Limit control by allowing the user to operate with a simplified menu structure.

**Note:**

When switching from a Limit control to an Express version, optional PM hardware (even though installed) and firmware features not available in a PM Express will no longer work. To see exactly what is impacted by this change, compare the chart below to the ordering information page in this document.

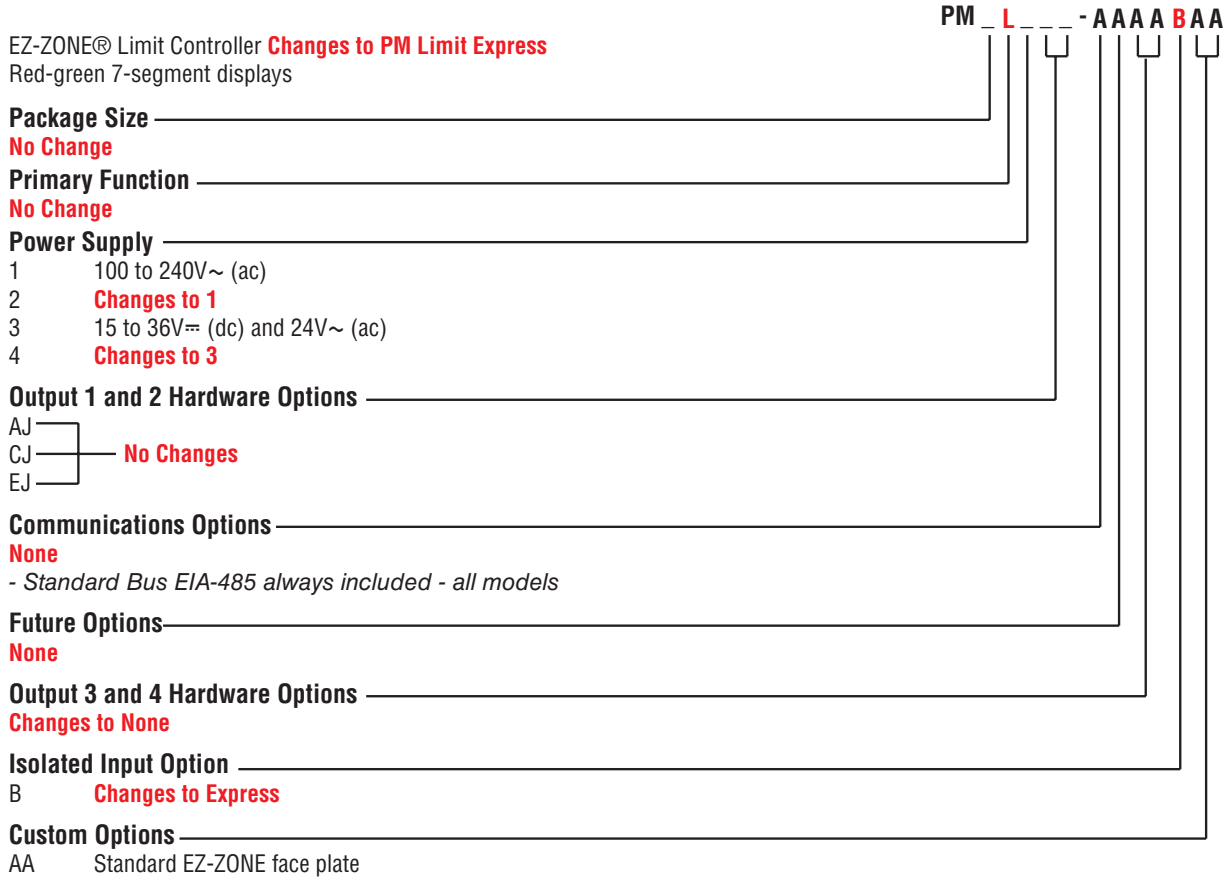

## How to Change the Control Model Number to a PM Express

1. Enter Factory Page [FCEY], Calibration Menu [CAL] via front panel or using EZ-ZONE Configurator Software.
2. Once there, using the green advance button navigate to the Part Number [Pn] prompt (lower display). The upper display will show factory [FCEY] indicating the factory model number as shown on the side of the control is currently in effect.
3. Push the green advance button one more time where the Public Key [CodE] prompt will be displayed in the lower display and the number [9999] in the upper display.
4. Using the up or down arrow keys enter 2501 and push the green advance button to execute the change.

**Note:**

As noted above, when switching from an integrated control to an Express version, optional hardware (even though installed) may no longer work. Also, all settings will be defaulted to that of a PM Express and a reset will occur when switched. If switching from a PM Express back to the PM Limit standard or enhanced, a reset will occur with all settings defaulted as shown in this document for the model as shipped from the factory.

**Note:**

After switching the model number to a PM Express this document will no longer apply to the control. Click on the link that follows to acquire the latest version of the PM PID Express User's Guide.

<http://www.watlow.com/literature/manuals.cfm>

Once there, simply enter express in the "Keyword" field to find the appropriate document.

## How to Restore Original PM Model Number

1. Enter Factory Page **[FCEY]**, Calibration Menu **[CAL]** via front panel or using EZ-ZONE Configurator Software.
2. Once there, using the green advance button navigate to the Part Number **[Pn]** prompt (lower display). The upper display will show User **[USER]** indicating the control is currently a PM Express.
3. Push the green advance button one more time where the Public Key **[CODE]** prompt will be displayed in the lower display and the number **[4999]** in the upper display.
4. Using the up or down arrow keys enter 606 and push the green advance button to execute the change.

### Note:

When switching from a PM Express back to the original model number all original optional hardware will again be enabled for use (assuming all original hardware is still installed). Also, when executing this step the control will be factory defaulted and then reset back to the original model number (as shown on the side of the control) at zone address 1. This User's Guide would once again apply to this control.

---

## Saving and Restoring User Settings

Recording setup and operations parameter settings for future reference is very important. If you unintentionally change these, you will need to program the correct settings back into the controller to return the equipment to operational condition.

After you program the controller and verify proper operation, use User Settings Save **[USR.S]** (Setup Page, Global Menu) to save the settings into either of two files in a special section of memory. If the settings in the controller are altered and you want to return the controller to the saved values, use User Restore Set **[USR.r]** (Setup Page, Global Menu) to recall one of the saved settings.

A digital input or the Function Key can also be configured to restore user settings.

### Note:

Only perform the above procedure when you are sure that all the correct settings are programmed into the controller. Saving the settings overwrites any previously saved collection of settings. Be sure to document all the controller settings.

### Note:

The control can also be brought back to the factory defaults. When doing so all previous user settings will be deleted, this would include user setting 1 and 2 along with any previously configured I/O assemblies.

---

## Programming the Home Page

Watlow's patented user-defined menu system improves operational efficiency. The user-defined Home Page provides you with a shortcut to monitor or change the parameter values that you use most often.

You can create your own Home Page with as many as 20 of the active parameters. When a parameter normally located in the Setup Page or Operations Page is placed in the Home Page, it is accessible through both. If you change a parameter in the Home Page, it is automatically changed in its original page. If you change a parameter in its original page it is automatically changed in the Home Page.

The default parameters will automatically appear in the Home Page.

Change the list of parameters in the Home Page from the Custom Menu **[CUSE]** (Factory Page).

---

## Inputs

### Calibration Offset

Calibration offset allows a device to compensate for an inaccurate sensor, lead resistance or other factors that affect the input value. A positive offset increases the input value, and a negative offset decreases the input value.

The input offset value can be viewed or changed with Calibration Offset **[i.CA]** (Operations Page, Analog Input Menu).

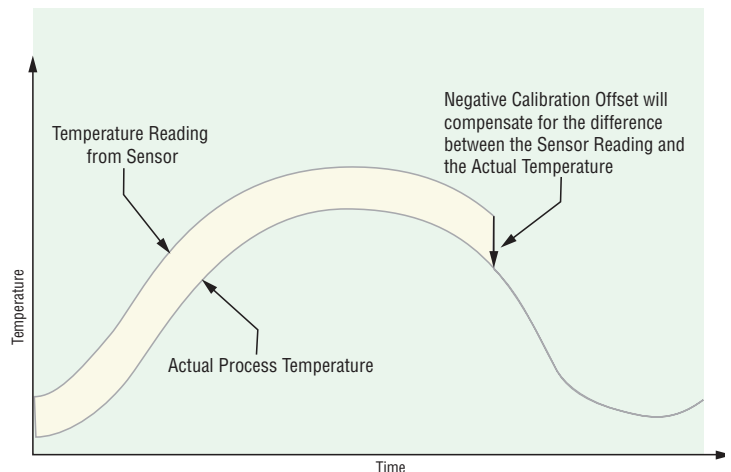

## Calibration

Before performing any calibration procedure, verify that the displayed readings are not within published specifications by inputting a known value from a precision source to the analog input. Next, subtract the displayed value with the known value and compare this difference to the published accuracy range specification for that type of input.

Use of the Calibration Offset  parameter found in the Operations Page , Analog Input Menu  shifts the readings across the entire displayed range by the offset value. Use this parameter to compensate for sensor error or sensor placement error. Typically this value is set to zero.

**Equipment required while performing calibration:** Obtain a precision source for millivolts, volts, milli-amperes or resistance depending on the sensor type to be calibrated. Use copper wire only to connect the precision source to the controller's input. Keep leads between the precision source and controller as short as possible to minimize error. In addition, a precision volt/ohm meter capable of reading values to 4 decimal places or better is recommended. Prior to calibration, connect this volt/ohm meter to the precision source to verify accuracy.

Actual input values do NOT have to be exactly the recommended values, but it IS critical that the actual value of the signal connected to the controller be accurately known to at least four digits.

### Calibration of Analog Inputs:

To calibrate an analog input, you will need to provide a source of two electrical signals or resistance values near the extremes of the range that the application is likely to utilize. See recommended values below:

Sensor Type	Precision Source Low	Precision Source High
thermocouple	0.000 mV	50.000 mV
millivolts	0.000 mV	50.000 mV
volts	0.000V	10.000V
milliamps	0.000 mA	20.000 mA
100 Ω RTD	50.00 Ω	350.0 Ω
1,000 Ω RTD	500.0 Ω	3,500 Ω
thermistor 5 kΩ	50.00	5,000
thermistor 10 kΩ	150.0	10,000
thermistor 20 kΩ	1,800	20,000
thermistor 40 kΩ	1,700	40,000
potentiometer	0.000	1,200

#### Note:

The user may only calibrate one sensor type. If the calibrator interferences with open thermocouple detection, set Sensor Type  in Setup Page , Analog Input Menu , to millivolt  instead of Thermocouple  to avoid interference between the calibrator and open thermocouple detect circuit for the duration of the calibration process. Be sure to set sensor type back to the thermocouple type utilized.

1. Disconnect the sensor from the controller.
2. Record the Calibration Offset  parameter value in the Operations Page , Analog Input Menu , then set value to zero.
3. Wire the precision source to the appropriate controller input terminals to be calibrated. Do not have any other wires connected to the input terminals. Please refer to the Install and Wiring section of this manual for the appropriate connections.
4. Ensure the controller sensor type is programmed to the appropriate Sensor Type  to be utilized in the Setup Page , Analog Input Menu .
5. Enter Factory Page , Calibration Menu  via RUI or EZ-ZONE Configurator Software.
6. Select the Calibration  input instance to be calibrated. This corresponds to the analog input to be calibrated.
7. Set Electrical Input Slope  to 1.000 and Electrical Input Offset  to 0.000 (this will cancel any prior user calibration values)
8. Input a Precision Source Low value. Read Electrical Measurement value  of controller via EZ-Configurator or RUI. This will be referred to as Electrical Measured Low. Record low value  
-----
9. Input a Precision Source High value.

10. Read Electrical Measurement value  $\boxed{P70}$  of controller via EZ-Configurator or RUI. This will be referred to as Electrical Measured High. Record high value \_\_\_\_\_
11. Calculated Electrical Input Slope = (Precision High – Precision Low) / (Electrical Measured High - Electrical Measured Low). Calculated Slope value \_\_\_\_\_
12. Calculated Electrical Input Offset = Precision Low – (Electrical Input Slope \* Measured Low). Calculated Offset value \_\_\_\_\_
13. Enter the calculated Electrical Input Slope  $\boxed{EL1.5}$  and Electrical Input Offset  $\boxed{EL1.0}$  into the controller.
14. Exit calibration menu.
15. Validate calibration process by utilizing a calibrator to the analog input.
16. Enter calibration offset as recorded in step 2 if required to compensate for sensor error.

Setting Electrical Input Slope  $\boxed{EL1.5}$  to 1.000 and Electrical Input Offset  $\boxed{EL1.0}$  to 0.000, restores factory calibration as shipped from factory.

---

## Filter Time Constant

Filtering smoothes an input signal by applying a first-order filter time constant to the signal. Filtering the displayed value makes it easier to monitor. Filtering the signal may improve the performance of PID control in a noisy or very dynamic system.

Adjust the filter time interval with Filter Time  $\boxed{F1L}$  (Setup Page, Analog Input Menu).

Example: With a filter value of 0.5 seconds, if the process input value instantly changes from 0 to 100 and remained at 100, the display will indicate 100 after five time constants of the filter value or 2.5 seconds.

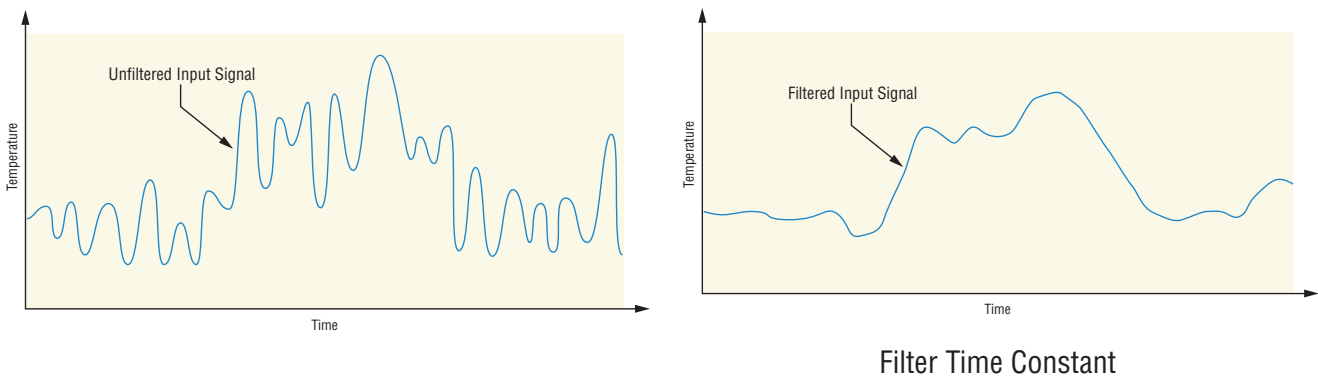

---

## Sensor Selection

You need to configure the controller to match the input device, which is normally a thermocouple, RTD or process transmitter. When you select an input device, the controller automatically sets the input linearization to match the sensor. It also sets high and low limits, which in turn limit the set point range-high and range-low values.

Select the sensor type with Sensor Type  $\boxed{SEn}$  (Setup Page, Analog Input Menu).

### Note:

The EZ-ZONE PM does not have an open-sensor detection feature for process inputs.

---

## Set Point Low Limit and High Limit

The controller constrains the Limit set point to a value between the Set Point Low Limit and the Set Point High Limit.

Set the set point range with Set Point Low Limit  $\boxed{SPLL}$  and Set Point HighLimit  $\boxed{SPLh}$  (Setup Page, Loop Menu).

## Scale High and Scale Low

When an analog input is selected as process voltage or process current input, you must choose the value of voltage or current to be the low and high ends. For example, when using a 4 to 20 mA input, the scale low value would be 4.00 mA and the scale high value would be 20.00 mA. Commonly used scale ranges are: 0 to 20 mA, 4 to 20 mA, 0 to 5V, 1 to 5V and 0 to 10V.

You can create a scale range representing other units for special applications. You can reverse scales from high values to low values for analog input signals that have a reversed action. For example, if 50 psi causes a 4 mA signal and 10 psi causes a 20 mA signal.

Scale low and high values do not have to match the bounds of the measurement range. These along with range low and high provide for process scaling and can include values not measureable by the controller. Regardless of scaling values, the measured value will be constrained by the electrical measurements of the hardware.

Select the low and high values with Scale Low  and Scale High . Select the displayed range with Range Low  and Range High  (Setup Page, Analog Input Menu).

---

## Range High and Range Low

With a process input, you must choose a value to represent the low and high ends of the current or voltage range. Choosing these values allows the controller's display to be scaled into the actual working units of measurement. For example, the analog input from a humidity transmitter could represent 0 to 100 percent relative humidity as a process signal of 4 to 20 mA. Low scale would be set to 0 to represent 4 mA and high scale set to 100 to represent 20 mA. The indication on the display would then represent percent humidity and range from 0 to 100 percent with an input of 4 to 20 mA.

Select the low and high values with Range Low  and Range High  (Setup Page, Analog Input Menu).

---

## Outputs

### Retransmitting a Process Value or Set Point

The retransmit feature allows a process output to provide an analog signal that represents the set point or process value. The signal may serve as a remote set point for another controller or as an input for a chart recorder documenting system performance over time.

In choosing the type of retransmit signal the operator must take into account the input impedance of the device to be retransmitted to and the required signal type, either voltage or milliamps.

Typically applications might use the retransmit option to record one of the variables with a chart recorder or to generate a set point for other controls in a multi-zone application.

Outputs 1 and 3 can be ordered as process outputs and used to retransmit. Select retransmit  as the Output Function  (Setup Page, Output Menu). Set the output to volts  or milliamps  with Output Type . Select the signal to retransmit with Retransmit Source .

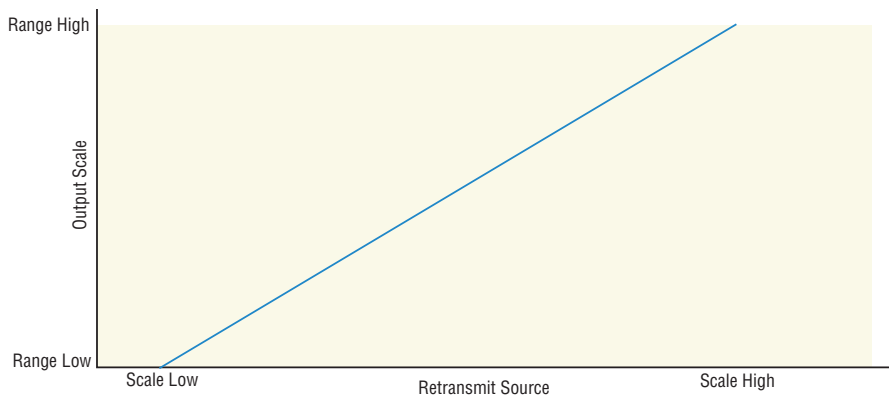



Set the range of the process output with Scale Low  and Scale High . Scale the retransmit source to the process output with Range Low  and Range High .

When the retransmit source is at the Range Low value, the retransmit output will be at its Scale Low value. When the retransmit source is at the Range High value, the retransmit output will be at its Scale High value.

## Resetting a Tripped Limit

Output 2 will always be a Form A (normally open) Mechanical Relay and it will always be internally tied to the limit function. When the limit is in a safe state the internal coil for this relay will be energized, therefore the relay will be closed. When a condition occurs that causes the limit to trip, the internal coil will deenergize causing the relay to latch open. When the condition that caused the limit to trip has been resolved, the relay will remain latched open until manually reset. The process to reset a latched limit can be different from control to control and is dependent upon the controller firmware version.

To check the firmware revision of your control do one of the following:

1. Cycle power to the control while observing the number in the top display (this momentary numerical display reflects the current installed firmware version).
2. Navigate to the Factory Page by simultaneously pushing and holding the Advance Key  and the Reset Key  for approximately 8 seconds and then use the up or down arrow key to navigate to the Diagnostic Menu. Once there, push the Advance Key twice where the revision  will be shown in the lower display and the upper display will indicate the current firmware revision.

### Prior to firmware release 11.0:

1. Push the Reset Key .
2. Configure a digital input with the Action Function set to Limit Reset (navigate to the Setup Page under the Digital I/O Menu).
3. Use a field bus protocol, i.e., Modbus, EtherNet/IP, etc...where a value of zero would be written to the associated address (navigate to the Operations Page and look for Limit Clear Request under the Limit Menu to find appropriate address).
4. Cycle the power to the controller.

### Firmware release 11.0 and above:

1. Push the Reset Key .
2. Follow the steps below:
  - 2a. Navigate to the Setup Page and then the Limit Menu
  - 2b. Set Source Function A to the desired device that will reset the limit (Digital I/O or Function Key)
  - 2c. Define the Source Instance
3. Use a field bus protocol, i.e., Modbus, EtherNet/IP, etc...where a value of zero would be written to the associated address (navigate to the Operations Page and look for Limit Clear Request under the Limit Menu to find appropriate address).
4. Cycle the power to the controller.

---

## Alarms

Alarms are activated when the output level, process value or temperature leaves a defined range. A user can configure how and when an alarm is triggered, what action it takes and whether it turns off automatically when the alarm condition is over.

Configure alarm outputs in the Setup Page before setting alarm set points.

Alarms do not have to be assigned to an output. Alarms can be monitored and controlled through the front panel or by using software.

---

## Process Alarms

A process alarm uses one or two absolute set points to define an alarm condition.

Select the alarm type with Type  (Setup Page, Alarm Menu).

---

## Alarm Set Points

The alarm high set point defines the process value or temperature that will trigger a high side alarm. It must be higher than the alarm low set point and lower than the high limit of the sensor range.

The alarm low set point defines the temperature that will trigger a low side alarm. It must be lower than the alarm high set point and higher than the low limit of the sensor range.

View or change alarm set points with Low Set Point  and High Set Point  (Operations Page, Alarm Menu).



## Alarm Hysteresis

An alarm state is triggered when the process value reaches the alarm high or alarm low set point. Alarm hysteresis defines how far the process must return into the normal operating range before the alarm can be cleared.

Alarm hysteresis is a zone inside each alarm set point. This zone is defined by adding the hysteresis value to the alarm low set point or subtracting the hysteresis value from the alarm high set point.

View or change alarm hysteresis with Hysteresis

**ALH** (Setup Page, Alarm Menu).

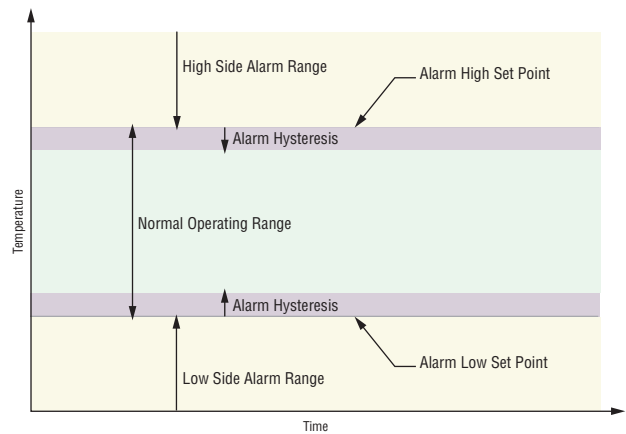

Alarm Set Points and Hysteresis

## Alarm Latching

A latched alarm will remain active after the alarm condition has passed. To clear a latched alarm, press the Reset  key. It can only be deactivated by the user. An alarm that is not latched (self-clearing) will deactivate automatically when the alarm condition has passed.

Turn alarm latching on or off with Latching  **ALA** (Setup Page, Alarm Menu).

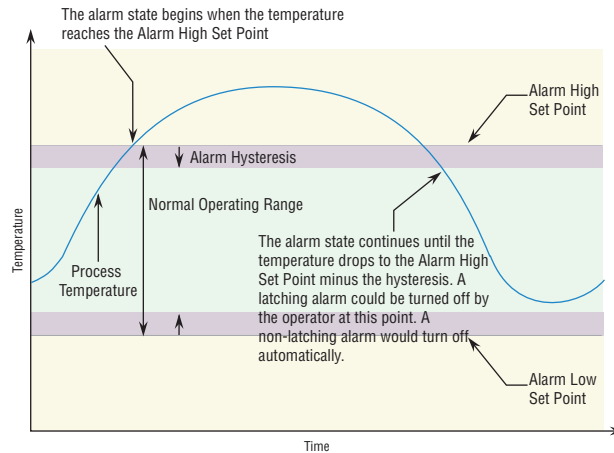

Alarm Response with Hysteresis

## Alarm Silencing

Alarm silencing allows the operator to disable the alarm output while the controller is in an alarm state. The process value or temperature has to enter the normal operating range beyond the hysteresis zone to activate the alarm output function again.

Turn alarm silencing on or off with Silencing  **ALS** (Setup Page, Alarm Menu).

## Alarm Blocking

Alarm blocking allows a system to warm up after it has been started up. With alarm blocking on, an alarm is not triggered when the process temperature is initially lower than the alarm low set point. The process temperature has to enter the normal operating range beyond the hysteresis zone to activate the alarm function.

Turn alarm blocking on or off with Blocking  **ABL** (Setup Page, Alarm Menu).

## Using Lockout and Password Security

If unintentional changes to parameter settings might raise safety concerns or lead to downtime, you can use the lockout feature to make them more secure. There are two methods of lockout that can be deployed, both of which are accessible from the Factory Page.

Method 1- Change the value of the Read Lock (**rLoc**) (1 to 5) and Set Lock (**SLoc**) (0 to 5) prompts where the higher the value or setting for each translates to a higher security clearance (greater access).

Method 2- Enable Password Security (**PASS**) and then modify the Lock Level (**LoCL**) value which ranges from 1 to 5. See the section entitled [Using Lockout Method 2](#) for more detail.

### Using Lockout Method 1 (Read and Set Lock)

All Pages have security levels assigned where two of those cannot be changed (Home and Setup). Defaults (factory settings) for each are shown below:

- Home Page = 1
- Operations Page = 2 (changeable to 1, 2 or 3)
- Setup Page = 4
- Factory Page = 5\*

\*The Factory Page is always visible where all menus within it may or may not be visible/writable. See tables below for further detail.

The table below represents the various levels of lockout for the Set Lockout Security prompt (**SLoc**) and the Read Lockout Security prompt (**rLoc**). Looking at the table, "Y" equates to yes (can write/read) where "N" equates to no (cannot write/read). The colored cells simply differentiate one level from the next. As stated previously, the Set Lockout has 6 levels (0 to 5) of security where the Read Lockout has 5 (1 to 5). Therefore, level "0" applies to Set Lockout only.

Lockout Security <b>SLoc</b> & <b>rLoc</b>						
Pages	Security Level					
	0	1	2	3	4	5
Home Page (cannot be changed)	N	Y	Y	Y	Y	Y
Operations Page	N	N	Y	Y	Y	Y
Setup Page (cannot be changed)	N	N	N	N	Y	Y
Factory Page	Y	Y	Y	Y	Y	Y

An example of Method 1 lockout usage could be that an operator wants read access to all pages while allowing read/write access to the Home Page and the Lockout Menu only.

1. Press and hold the Advance and Infinity keys for approximately 6 seconds to enter the Factory Page
2. Navigate to the **LoC** Menu using the Up or Down arrow keys
3. Using the green Advance key navigate to the Read Lockout Security (**rLoc**) and change it to 5
4. Push the green Advance key and navigate to the and Set Lockout Security (**SLoc**) changing it to 1

Although the Factory Page is always visible, some menus within it can be restricted.

Lockout Security <b>SLoc</b> & <b>rLoc</b>						
Factory Page Menus						
Menus	Security Level					
	0	1	2	3	4	5
Custom Menu	N	N	N	N	N	Y
Lockout Menu*	Y	Y	Y	Y	Y	Y
Diagnostic Menu**	N	Y	Y	Y	Y	Y
Calibration Menu	N	N	N	N	N	Y

\* Using lockout Method 1 with **SLoc** set to 0, all writable parameters within the control will be inhibited (not writable) with two exceptions, **SLoc** and **rLoc**. As shown below, both of these parameters can always be seen and modified.

\*\* Diagnostic Menu and all associated prompts are always visible and never writable.

Lockout Security (SLoC) & (rLoC)						
Factory Page Menu Parameters						
Parameters	Security Level					
	0	1	2	3	4	5
LoC.D	N	Y	Y	Y	Y	Y
PAS.E	N	Y	Y	Y	Y	Y
rLoC	Y	Y	Y	Y	Y	Y
SLoC	Y	Y	Y	Y	Y	Y

**Note:**

When using Method 1 Lockout all settings can be modified by anyone who knows how to find their way to the (SLoC) and (rLoC) parameters

### Using Lockout Method 2 (Password Enable)

It is sometimes desirable to apply a higher level of security to the control where a password would be required to access the control. If Password Enabled (PAS.E) in the Factory Page under the (LoC) Menu is set to on, an overriding Password Security will be in effect. Without the appropriate password, specified menus will remain inaccessible. Page and Menu access is defined in the Locked Access Level (LoC.L) prompt. On the other hand, a User with a password would have visibility restricted by the Read Lockout Security (rLoC). As an example, with Password Enabled and the Locked Access Level (LoC.L) set to 1 and (rLoC) is set to 3, the available Pages for a User without a password would be limited to the Home and Factory Pages (locked level 1). If the User password is entered all pages would be accessible with the exception of the Setup Page as defined by level 3 access.

#### How to Enable Password Security

Follow the steps below:

1. Go to the Factory Page by holding down the Reset (RES) key and the Advance (ADV) key for approximately six seconds.
2. Push the Down (DOWN) key one time to get to the (LoC) menu. Again push the Advance (ADV) key until the Password Enabled (PAS.E) prompt is visible.
3. Push either the up or down key to turn it on. Once on, 4 new prompts will appear:
  - a. (LoC.L), Locked Access Level (1 to 5) corresponding to the lockout table above.
  - b. (rLoC), Rolling Password will change the Customer Code every time power is cycled.
  - c. (PAS.U), User Password which is needed for a User to acquire access to the control.
  - d. (PAS.A), Administrator Password which is needed to acquire administrative access to the control.

The Administrator can either change the User and or the Administrator password or leave them in the default state. Once Password Security is enabled they will no longer be visible to anyone other than the Administrator. In other words the Lock Menu (LoC) is not available to a User. As can be seen in the formula that follows either the User or Administrator will need to know what those passwords are to acquire a higher level of access to the control. Back out of this menu by pushing the Infinity (INF) key. Once out of the menu, the Password Security will be enabled.

#### How to Acquire Access to the Control

To acquire access to any inaccessible Pages or Menus, go to the Factory Page and enter the (ULoC) menu. Once there follow the steps below:

**Note:**

If Password Security (Password Enabled (PAS.E) is On) is enabled the two prompts mentioned below in the first step will not be visible. If the password is unknown, call the individual or company that originally setup the control.

1. Acquire either the User Password (PAS.U) or the Administrator Password (PAS.A).
2. Push the Advance (ADV) key one time where the Code (CoDE) prompt will be visible.

**Note:**

- a. If the the Rolling Password is off push the Ad-vance key one more time where the Password **[PASS]** prompt will be displayed. Proceed to either step 7a or 8a. Pushing the Up **▲** or Down **▼** arrow keys enter either the User or Administrator Password. Once entered, push and hold the Reset **⏻** key for two seconds to return to the Home Page.
  - b. If the Rolling Password **[ROLL]** was turned on proceed on through steps 3 - 9.
3. Assuming the Code **[Code]** prompt (Public Key) is still visible on the face of the control simply push the Advance key **⏻** to proceed to the Password **[PASS]** prompt. If not find your way back to the Factory Page as described above.
  4. Execute the calculation defined below (7b or 8b) for either the User or Administrator.
  5. Enter the result of the calculation in the upper display play by using the Up **▲** and Down **▼** arrow keys or use EZ-ZONE Configurator Software.
  6. Exit the Factory Page by pushing and holding the Reset **⏻** key for two seconds.

Formulas used by the User and the Administrator to calculate the Password follows:

Passwords equal:

**7. User**

- a. If Rolling Password **[ROLL]** is Off, Password **[PASS]** equals User Password **[PASS,U]**.
- b. If Rolling Password **[ROLL]** is On, Password **[PASS]** equals:  $((PASS,U) \times code) \text{ Mod } 929 + 70$

**8. Administrator**

- a. If Rolling Password **[ROLL]** is Off, Password **[PASS]** equals User Password **[PASS,A]**.
- b. If Rolling Password **[ROLL]** is On, Password **[PASS]** equals:  $((PASS,A) \times code) \text{ Mod } 997 + 1000$

## Modbus - Using Programmable Memory Blocks

When using the Modbus RTU or Modbus TCP protocols, the PM control features a block of addresses that can be configured by the user to provide direct access to a list of 40 user configured parameters. This allows the user easy access to this customized list by reading from or writing to a contiguous block of registers.

To acquire a better understanding of the tables found in the back of this manual (See Appendix: [Modbus Programmable Memory Blocks](#)) please read through the text below which defines the column headers used.

### Assembly Definition Addresses

- Fixed addresses used to define the parameter that will be stored in the "Working Addresses", which may also be referred to as a pointer. The value stored in these addresses will reflect (point to) the Modbus address of a parameter within the ST control.

### Assembly Working Addresses

- Fixed addresses directly related to their associated "Assembly Definition Addresses" (i.e., Assembly Working Addresses 200 & 201 will assume the parameter pointed to by Assembly Definition Addresses 40 & 41).

When the Modbus address of a target parameter is stored in an "Assembly Definition Address" its corresponding working address will return that parameter's actual value. If it's a writable parameter, writing to its working register will change the parameter's actual value.

As an example, Modbus register 360 contains the Analog Input 1 Process Value (See Operations Page, Analog Input Menu). If the value 360 is loaded into Assembly Definition Address 91, the process value sensed by analog input 1 will also be stored in Modbus registers 250 and 251. Note that by default this parameter is also stored in working registers 240 and 241 as well.

The table (See Appendix: Modbus Programmable Memory Blocks) identified as "Assembly Definition Addresses and Assembly Working Addresses" reflects the assemblies and their associated addresses.

## CIP - Communications Capabilities

With the introduction of CIP a user can now collect data, configure a device and control industrial devices. CIP is an open protocol at the application layer fully managed by the Open DeviceNet Vendors Association (ODVA, <http://www.odva.org>). Being that this is an open protocol there are many independent vendors offering a wide array of devices to the end user. CIP provides the ability to communicate utilizing both implicit messaging (real-time I/O messaging), and explicit messaging (information/configuration messaging). For implicit communications using a PLC, simply configure the PM assembly size into the I/O structure of the PLC (See: [CIP Implicit Assembly Structures](#)). The assembly structures can also be changed by the user.

Explicit communications requires the use of specific addressing information. DeviceNet requires that the node address be specified where EtherNet/IP requires just the Class, Instance and Attribute.

- Node address or MAC ID (0 - 63, DeviceNet only)
- Class ID (1 to 255)
- Instance ID (0 to 255)
- Attribute ID (1 to 255)

EtherNet/IP and DeviceNet are both based on CIP and use the same addressing scheme. In the following menu pages notice the column header identified as CIP. There you will find the Class, Instance and Attribute in hexadecimal, (decimal in parenthesis) which makes up the addressing for both protocols. The Watlow implementation of CIP does not support connected explicit messages but fully supports unconnected explicit messaging.

Rockwell Automation (RA) developed the DF1 serial protocol within the framework of the PCCC application protocol. With the introduction of CIP, the PCCC protocol was encapsulated within it to enable continued communication over Ethernet to the legacy RA programmable controllers, e.g., SLC, Micrologic and PLC-5 controllers equipped with Ethernet capabilities. The Watlow implementation of CIP also supports the PCCC protocol.

EtherNet/IP (Industrial Protocol) is a network communication standard capable of handling large amounts of data at speeds of 10 Mbps or 100 Mbps, and at up to 1,500 bytes per packet. It makes use of standard off-the-shelf Ethernet chip sets and the currently installed physical media (hardware connections). DeviceNet was the first field bus offering of the ODVA group and has been around for many years. DeviceNet can communicate at 125, 250 and 500 kilobytes per second with a maximum limitation of 64 nodes (0 to 63) on the network.

### Note:

If the control is brought back to the factory defaults the user configured assemblies will be overwritten.

### Note:

The maximum number of implicit input/output members using *DeviceNet* is 200. When using EtherNet/IP the maximum is 100.

---

## CIP Implicit Assemblies

Communications using CIP (EtherNet/IP and DeviceNet) can be accomplished with any PM Integrated control equipped with either DeviceNet or EtherNet/IP communications cards. As was already mentioned, reading or writing when using CIP can be accomplished via explicit and or implicit communications. Explicit communications are usually executed via a message instruction within the PLC but there are other ways to do this as well outside of the focus of this document.

Implicit communications is also commonly referred to as polled communications. When using implicit communications there is an I/O assembly that would be read or written to. The default assemblies and the assembly size is embedded into the firmware of the PM control. Watlow refers to these assemblies as the T to O (Target to Originator) and the O to T (Originator to Target) assemblies where the Target is always the EZ-ZONE PM controller and the Originator is the PLC or master on the network. The size of the O to T assembly is fixed at 20 (32-bit) members where the T to O assembly consists of 21 (32-bit) members. All assembly members are user configurable with the exception of the first T to O member. The first member of the T to O assembly is called the Device Status, it is unique and cannot be changed. If the module has been properly configured when viewing this 32-bit member in binary format bits 12 and 16 should always be set to 1 where all of the other bits should be 0. The 20 members that follow Device Status are user configurable. The Appendix of this User's Guide contains the PM implicit assemblies (See Appendix: [CIP Implicit Assembly Structures](#)).

## Compact Assembly Class

Along with the standard implicit assembly where each module parameter (member) occupies one 32-bit assembly location there is also a Compact Class assembly. The need for the Compact Class assembly members became apparent as the number of member instances grew with the EZ-ZONE family of controls. Because there is a limited number of implicit assembly members (20 input, 20 output), the Compact Class enables the user to modify the standard assembly offering to their liking while also achieving much better utilization of each bit within the 32-bit member. As an example, if a standard Implicit Assembly member were configured to monitor Alarm State 1 the entire 32-bit member would be consumed where just 7 bits out of the 32 will be used to reflect: Startup (88), None (61), Blocked (12), Alarm Low (8), Alarm High (7) or Error (28) for Alarm 1 only. With Compact Class assembly member 12 (identified in this document as "[12 A Alarm Read](#)") in use, the alarm states of all 4 alarms can be placed in one 32-bit assembly member using just 2 bits for each state. Bits 0 and 1 would represent Alarm State 1, bits 2 and 3 Alarm State 2, etc... Each pair of 2 bits can represent the following states: 00 = None, 01 = Alarm Low, 10 = Alarm High and 11 = Other. There is a variety of predefined Compact Class members that can be used (See Appendix: [Compact Class Assembly Structure](#)) to modify the default implicit assemblies.

### Note:

As is the case with any available parameter within the PM control the Compact Class members can also be read or written to individually via an explicit message as well.

---

## Modifying Implicit Assembly Members

To change any given member of either assembly (T to O or O to T) simply write the new class, instance and attribute (CIA) to the member location of choice. As an example, if it were desired to change the 14<sup>th</sup> member of the T to O assembly from the default parameter (Cool Power) to the Compact Class 12<sup>th</sup> member (See Appendix: [Compact Class Assembly Structure](#)) write the value of 0x71, 0x01 and 0x0C (Class, Instance and Attribute respectively) to 0x77, 0x02 and 0x0D. Once the change is executed, reading this member location (as was discussed above) will return the Alarm States (1-4) to paired bits 0 through 7 where 00 = None, 01 = Alarm Low, 10 = Alarm High and 11 = Other.

The CIP communications instance will always be instance 2.

---

## Profibus DP - (Decentralized Peripherals)

This protocol is typically used to operate sensors and actuators via a centralized controller within industrialized production topologies. Data rates up to 12 Mbit/s on twisted pair cables and/or fiber optics are possible. This protocol is available in three functionally graded version; DP-V0, DP-V1 and DP-V2. It should be noted that Watlow products utilizing this protocol support DP-V0 and DP-V1 only.

DP-V0 - provides the basic functionality of DP, including cyclic data exchange, station, module and channel specific diagnostics and four different interrupt types for diagnostics and process interrupts.

*Cyclic Data* refers to input/output data that is pre-configured to pass from the Profibus-DP Class 1 Master and the Slave at a known rate. Cyclic data is expected on both the sender and the receiver end of the message.

### Note:

To use DP-V0 (cyclic data transfer) first configure and then register the General Station Description (GSD) file. Watlow provides a software tool allowing for total customization of the data to be read and or written to. Acquire this software tool (Profibus GSD Editor) via the CD that shipped with the product or, as an alternative, point your browser to: <http://www.watlow.com/products/controllers/software.cfm> and navigate to the bottom of the page and click on "Software and Demos" to download the software.

Using the GSD Editor a user can configure up to a maximum of 135 different parameters that can be read or written to from Zone 1 through 16.

DP-V1 - contains enhancements geared towards process automation, in particular acyclic data communication for parameter assignment, operation, visualization and interrupt control of intelligent field devices, in conjunction with cyclic user data communication.

*Acyclic Data* is a message that can be sent and or received at any time where they typically have a lower priority than cyclic messages. This type of messaging is typically used for the purpose of configuration or performing some sort of a diagnostic function.

# Software Configuration

## Using EZ-ZONE® Configurator Software

To enable a user to configure the PML (Limit) control using a personal computer (PC), Watlow has provided free software for your use. If you have not yet obtained a copy of this software insert the CD (Controller Support Tools) into your CD drive and install the software. Alternatively, if you are viewing this document electronically and have a connection to the internet simply click on the link below and download the software from the Watlow web site free of charge.

[http://www.watlow.com/products/software/zone\\_config.cfm](http://www.watlow.com/products/software/zone_config.cfm)

Once the software is installed double click on the EZ-ZONE Configurator icon placed on your desktop during the installation process. If you cannot find the icon follow the steps below to run the software:

1. Move your mouse to the "Start" button
2. Place the mouse over "All Programs"
3. Navigate to the "Watlow" folder and then the subfolder "EZ-ZONE Configurator"
4. Click on EZ-ZONE Configurator to run.

The first screen that will appear is shown to the right. If the PC is already physically connected to the EZ-ZONE PML control click the next button to go on-line.

### Note:

When establishing communications from PC to the EZ-ZONE PML an interface converter will be required. The Standard Bus network uses EIA-485 as the interface. Most PCs today would require a USB to EIA-485 converter. However, some PCs may still be equipped with EIA-232 ports, therefore an EIA-232 to EIA-485 converter would be required.

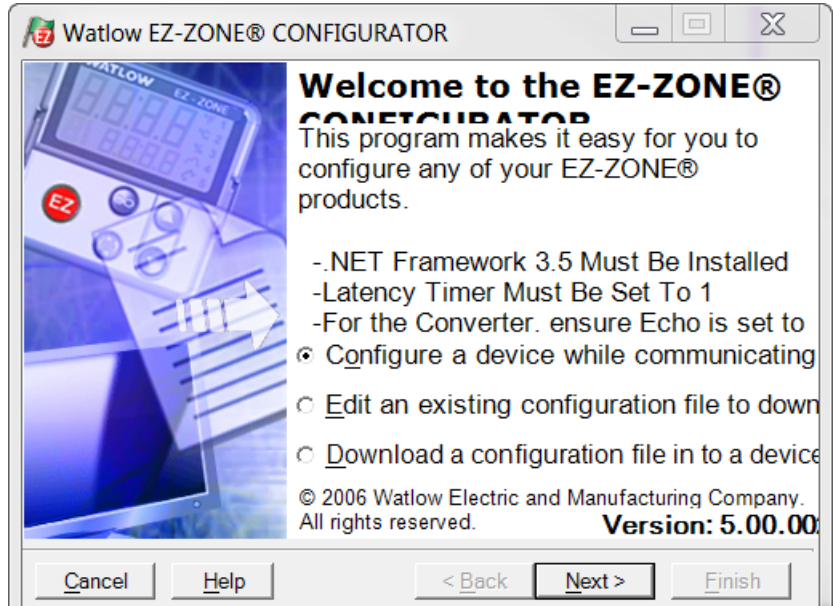

As can be seen in the above screen shot the software provides the user with the option of downloading a previously saved configuration as well as the ability to create a configuration off-line to download later. The screen shots that follow will take the user on-line.

After clicking the next button above it is necessary to define the communications port that will be used on the PC as shown below. Clicking on the drop down will allow the user to select the appropriate communications port. This will be the port assigned to the EIA-485 to USB converter when it was connected to the PC. The "Advanced" button allows the user to determine how many devices to look for on the network (1 to 17).

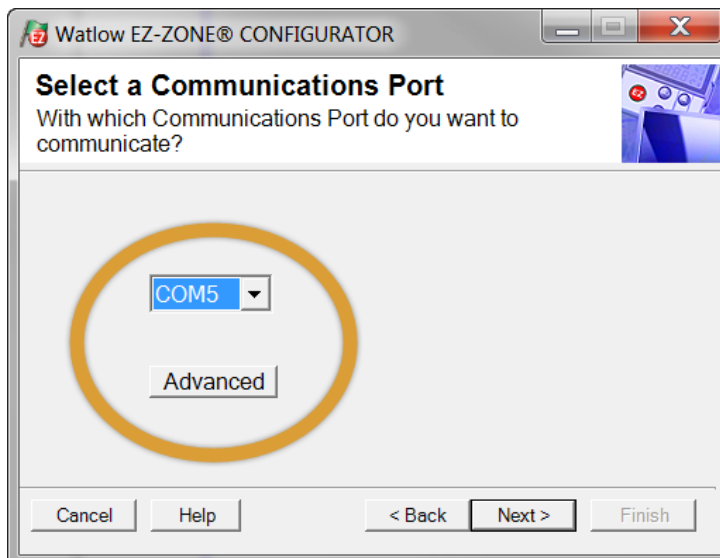

After clicking on the "Next" button, the software will scan the network for the zone addresses specified while showing the progress made (as shown in the graphic below. When complete the software will display all of the available devices found on the network as shown below

### Searching Network for Devices

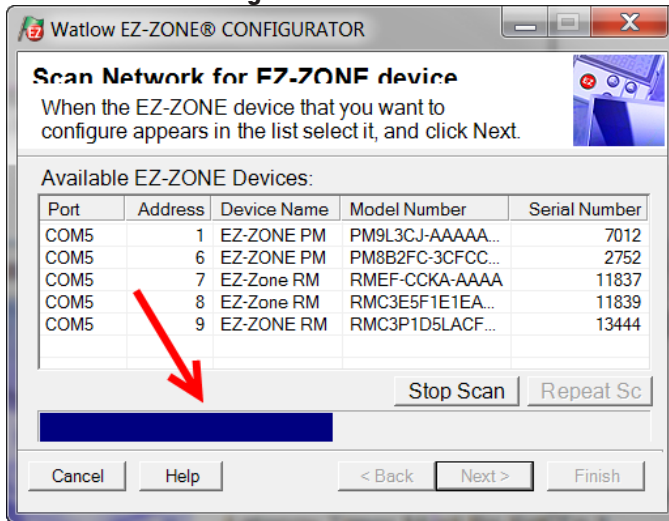

### Available Network Devices Displayed

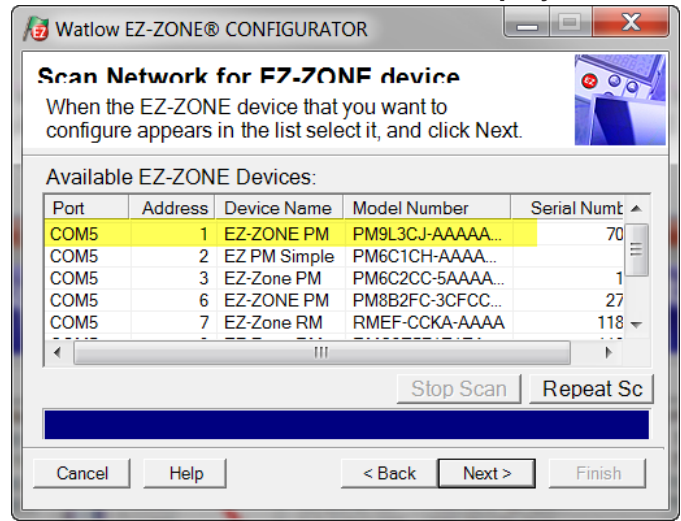

The PM9L is shown highlighted to bring greater clarity to the control in focus. Any EZ-ZONE device on the network will appear in this window and would be available for the purpose of configuration or monitoring; simply click on the control of choice. After doing so, the screen below will appear. In the screen shot below notice that the device part number is clearly displayed at the top of the page (yellow highlight added for emphasis). When multiple EZ-ZONE devices are on the network it is important that the part number be noted prior to configuring so as to avoid making unwanted configuration changes to another control. Looking closely at the left hand column (Parameter Menus) notice that it displays all of the available menus and associated pa-

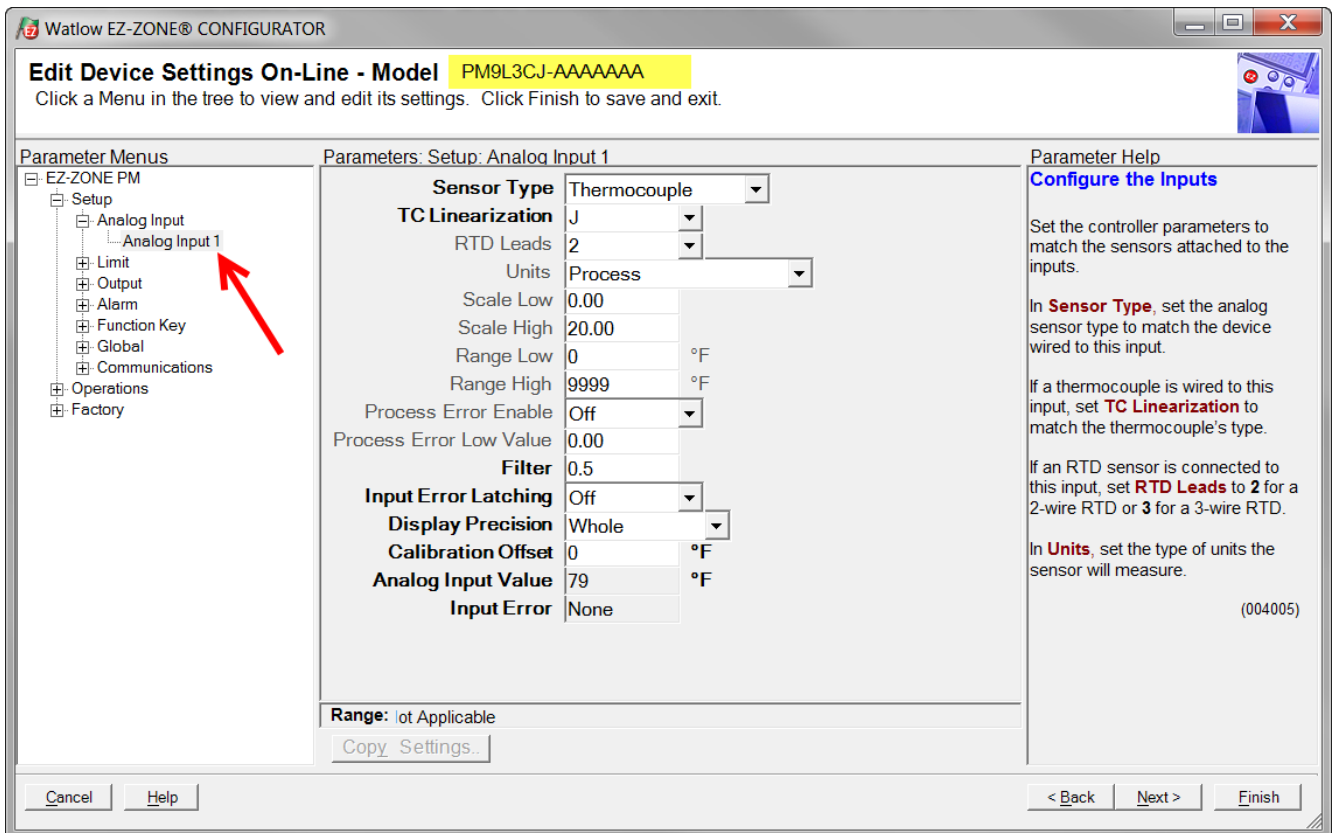

rameters within the control. The menu structure as laid out within this software follows:  
 - Setup - Operations - Factory



Navigating from one menu to the next is easy and clearly visible. Simply slide the scroll bar up or down to display the menu and parameter of choice. If there is a need to bring greater focus and clarity to the parameters of interest simply click on the negative symbol next to any of the Menu items. As an example if it is desired to work within the Operations page click the negative sign next to Setup where the Setup Page will then collapse. Now click the plus sign next to Operations to find the menu items of choice without viewing unwanted menus and parameters. Once the focus is brought to an individual parameter (single click of mouse) as is the case for Analog Input 1 in the left column; all that can be setup related to that parameter will appear in the center column. The grayed out fields in the center column simply mean that this does not apply for the type of sensor selected. As an example, notice that when a thermocouple is selected, RTD Leads does not apply and is therefore grayed out. To speed up the process of configuration notice that at the bottom of the center column there is an option to copy settings. If Analog Input 1 and 2 are the same type of sensor click on "Copy Settings" where a copy dialog box will appear allowing for quick duplication of all settings. Notice too, that by clicking on any of those items in the center column that context sensitive help will appear for that particular item in the right hand column.

Lastly, when the configuration is complete click the "Finish" button at the bottom right of the previous screen shot. The screen that follows this action can be seen below.

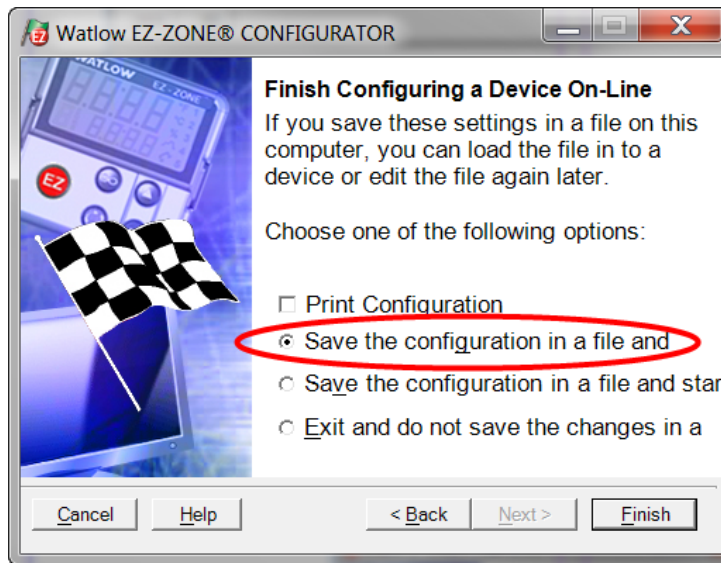

Although the PM Limit control now contains the configuration (because the previous discussion focused on doing the configuration on-line) it is suggested that after the configuration process is completed that the user save this file on the PC for future use. If for some reason someone inadvertently changed a setting without understanding the impact, it would be easy and perhaps faster to download a saved configuration back to the control versus trying to figure out what was changed. Of course, there is an option to exit without saving a copy to the local hard drive. After selecting Save above, click the "Finish" button once again. The screen below will then appear. When saving the configuration, note the location where the file will be placed (saved in) and enter the file name (File name) as well. The default path for saved files follows: Users\Username\My Documents\Watlow\EZ-Zone Configurator\Saved Configurations

The user can save the file to any folder of choice.

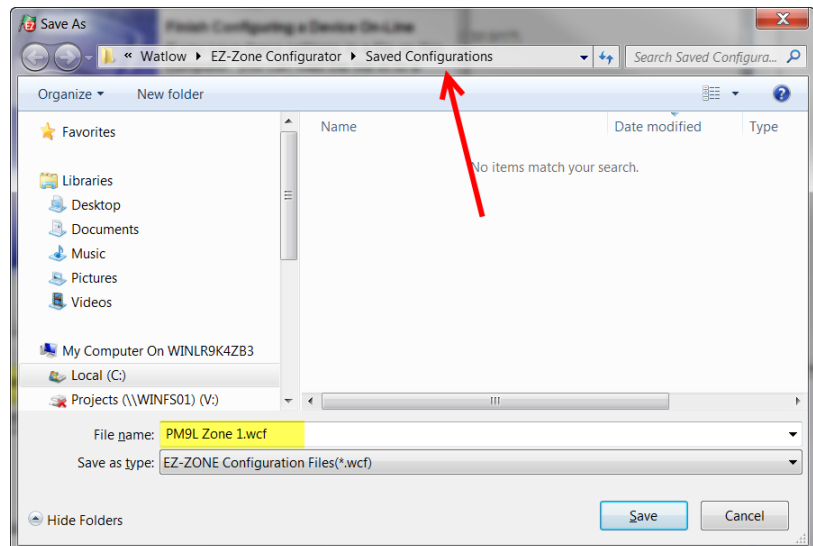

# Chapter 9: Appendix

## Troubleshooting Alarms, Errors and Control Issues

Indication	Description	Possible Cause(s)	Corrective Action
Alarm won't clear or Reset	Alarm will not clear or Reset with keypad or digital input	<ul style="list-style-type: none"> <li>Alarm latching is active</li> <li>Alarm set to incorrect output</li> <li>Alarm is set to incorrect source</li> <li>Sensor input is out of alarm set point range</li> <li>Alarm set point is incorrect</li> <li>Alarm is set to incorrect type</li> <li>Digital input function is incorrect</li> </ul>	<ul style="list-style-type: none"> <li>Reset alarm when process is within range or disable latching</li> <li>Set output to correct alarm source instance</li> <li>Set alarm source to correct input instance</li> <li>Correct cause of sensor input out of alarm range</li> <li>Set alarm set point to correct trip point</li> <li>Set digital input function and source instance</li> </ul>
Alarm won't occur	Alarm will not activate output	<ul style="list-style-type: none"> <li>Alarm silencing is active</li> <li>Alarm blocking is active</li> <li>Alarm is set to incorrect output</li> <li>Alarm is set to incorrect source</li> <li>Alarm set point is incorrect</li> <li>Alarm is set to incorrect type</li> </ul>	<ul style="list-style-type: none"> <li>Disable alarm silencing, if required</li> <li>Disable alarm blocking, if required</li> <li>Set output to correct alarm source instance</li> <li>Set alarm source to correct input instance</li> <li>Set alarm set point to correct trip point</li> </ul>
<b>AL.E1</b> Alarm Error <b>AL.E2</b> <b>AL.E3</b> <b>AL.E4</b>	Alarm state cannot be determined due to lack of sensor input	<ul style="list-style-type: none"> <li>Sensor improperly wired or open</li> <li>Incorrect setting of sensor type</li> <li>Calibration corrupt</li> </ul>	<ul style="list-style-type: none"> <li>Correct wiring or replace sensor</li> <li>Match setting to sensor used</li> <li>Check calibration of controller</li> </ul>
<b>AL.L1</b> Alarm Low <b>AL.L2</b> <b>AL.L3</b> <b>AL.L4</b>	Sensor input below low alarm set point	<ul style="list-style-type: none"> <li>Temperature is less than alarm set point</li> <li>Alarm is set to latching and an alarm occurred in the past</li> <li>Incorrect alarm set point</li> <li>Incorrect alarm source</li> </ul>	<ul style="list-style-type: none"> <li>Check cause of under temperature</li> <li>Clear latched alarm</li> <li>Establish correct alarm set point</li> <li>Set alarm source to proper setting</li> </ul>
<b>AL.H1</b> Alarm High <b>AL.H2</b> <b>AL.H3</b> <b>AL.H4</b>	Sensor input above high alarm set point	<ul style="list-style-type: none"> <li>Temperature is greater than alarm set point</li> <li>Alarm is set to latching and an alarm occurred in the past</li> <li>Incorrect alarm set point</li> <li>Incorrect alarm source</li> </ul>	<ul style="list-style-type: none"> <li>Check cause of over temperature</li> <li>Clear latched alarm</li> <li>Establish correct alarm set point</li> <li>Set alarm source to proper setting</li> </ul>
<b>Er. I</b> Error Input	Sensor does not provide a valid signal to controller	<ul style="list-style-type: none"> <li>Sensor improperly wired or open</li> <li>Incorrect setting of sensor type</li> <li>Calibration corrupt</li> </ul>	<ul style="list-style-type: none"> <li>Correct wiring or replace sensor</li> <li>Match setting to sensor used</li> <li>Check calibration of controller</li> </ul>
Limit won't clear or Reset	Limit will not clear or Reset with keypad or digital input	<ul style="list-style-type: none"> <li>Sensor input is out of limit set point range</li> <li>Limit set point is incorrect</li> <li>Digital input function is incorrect</li> </ul>	<ul style="list-style-type: none"> <li>Correct cause of sensor input out of limit range</li> <li>Set limit set point to correct trip point</li> <li>Set digital input function and source instance</li> </ul>
<b>L.L1</b> Limit Error	Limit state cannot be determined due to lack of sensor input, limit will trip	<ul style="list-style-type: none"> <li>Sensor improperly wired or open</li> <li>Incorrect setting of sensor type</li> <li>Calibration corrupt</li> </ul>	<ul style="list-style-type: none"> <li>Correct wiring or replace sensor</li> <li>Match setting to sensor used</li> <li>Check calibration of controller</li> </ul>
<b>L.L1</b> Limit Low	Sensor input below low limit set point	<ul style="list-style-type: none"> <li>Temperature is less than limit set point</li> <li>Limit outputs latch and require Reset</li> <li>Incorrect alarm set point</li> </ul>	<ul style="list-style-type: none"> <li>Check cause of under temperature</li> <li>Clear limit</li> <li>Establish correct limit set point</li> </ul>

Indication	Description	Possible Cause(s)	Corrective Action
<b>L h I</b> Limit High	Sensor input above high limit set point	<ul style="list-style-type: none"> <li>• Temperature is greater than limit set point</li> <li>• Limit outputs latch and require Reset</li> <li>• Incorrect alarm set point</li> </ul>	<ul style="list-style-type: none"> <li>• Check cause of over temperature</li> <li>• Clear limit</li> <li>• Establish correct limit set point</li> </ul>
No Display	No display indication or LED illumination	<ul style="list-style-type: none"> <li>• Power to controller is off</li> <li>• Fuse open</li> <li>• Breaker tripped</li> <li>• Safety interlock switch open</li> <li>• Separate system limit control activated</li> <li>• Wiring error</li> <li>• Incorrect voltage to controller</li> </ul>	<ul style="list-style-type: none"> <li>• Turn on power</li> <li>• Replace fuse</li> <li>• Reset breaker</li> <li>• Close interlock switch</li> <li>• Reset limit</li> <li>• Correct wiring issue</li> <li>• Apply correct voltage, check part number</li> </ul>
No Serial Communication	Cannot establish serial communications with the controller	<ul style="list-style-type: none"> <li>• Address parameter incorrect</li> <li>• Incorrect protocol selected</li> <li>• Baud rate incorrect</li> <li>• Parity incorrect</li> <li>• Wiring error</li> <li>• EIA-485 converter issue</li> <li>• Incorrect computer or PLC communications port</li> <li>• Incorrect software setup</li> <li>• Termination resistor may be required</li> </ul>	<ul style="list-style-type: none"> <li>• Set unique addresses on network</li> <li>• Match protocol between devices</li> <li>• Match baud rate between devices</li> <li>• Match parity between devices</li> <li>• Correct wiring issue</li> <li>• Check settings or replace converter</li> <li>• Set correct communication port</li> <li>• Correct software setup to match controller</li> <li>• Place 120 Ω resistor across EIA-485 on last controller</li> </ul>
Temperature runaway	Process value continues to increase or decrease past set point.	<ul style="list-style-type: none"> <li>• Controller output incorrectly programmed</li> <li>• Thermocouple reverse wired</li> <li>• Controller output wired incorrectly</li> <li>• Short in heater</li> <li>• Power controller connection to controller defective</li> <li>• Controller output defective</li> </ul>	<ul style="list-style-type: none"> <li>• Verify output function is correct (heat or cool)</li> <li>• Correct sensor wiring (red wire negative)</li> <li>• Verify and correct wiring</li> <li>• Replace heater</li> <li>• Replace or repair power controller</li> <li>• Replace or repair controller</li> </ul>
<b>100</b> Device Error <b>rEEr</b>	Controller displays internal malfunction message at power up.	<ul style="list-style-type: none"> <li>• Controller defective</li> <li>• Miss wired input or ground loop</li> </ul>	<ul style="list-style-type: none"> <li>• Replace or repair controller</li> <li>• Correct wiring or remove ground loop circuit</li> </ul>
Menus inaccessible	Unable to access <b>SEt</b> , <b>OPEr</b> , <b>FLtY</b> or <b>PrOF</b> menus or particular prompts in Home Page	<ul style="list-style-type: none"> <li>• Lockout or Security set to incorrect level</li> <li>• Digital input set to lockout keypad</li> <li>• Custom parameters incorrect</li> </ul>	<ul style="list-style-type: none"> <li>• Check lockout setting in Factory Page</li> <li>• Change state of digital input</li> <li>• Change custom parameters in Factory Page</li> </ul>
EZ-Key/s doesn't work	EZ-Key does not activate required function	<ul style="list-style-type: none"> <li>• EZ-Key function incorrect</li> <li>• EZ-Key function instance not incorrect</li> <li>• Keypad malfunction</li> </ul>	<ul style="list-style-type: none"> <li>• Verify EZ-Key function in Setup Menu</li> <li>• Check that the function instance is correct</li> <li>• Replace or repair controller</li> </ul>
<b>uRLl</b> Value to low	Value to low to be displayed in 4 digit LED display <-1999	<ul style="list-style-type: none"> <li>• Incorrect setup</li> </ul>	<ul style="list-style-type: none"> <li>• Check scaling of source data</li> </ul>
<b>uRLh</b> Value to high	Value to high to be displayed in 4 digit LED display >9999	<ul style="list-style-type: none"> <li>• Incorrect setup</li> </ul>	<ul style="list-style-type: none"> <li>• Check scaling of source data</li> </ul>

Detection of and Rules Around Abnormal Sensor Conditions	
Inputs	Detection of Abnormal Conditions
<b>Thermocouple</b>	
Shorted	No direct detection, Open loop firmware detection.
Open	Yes, Parasitic pull-up
Reversed	Yes, firmware detection
<b>Current Source</b>	
Shorted	Range limiting only
Open	Range limiting only
Reversed	Range limiting only
<b>Voltage Source</b>	
Open	Range limiting only
Shorted	Range limiting only
Reversed	Range limiting only
<b>RTD</b>	
S1 open	Yes, pulled up.
S2 open	Not implemented.
S3 open	Yes, pulled up.
S1 short to S2	Yes, pulled up
S1 short to S3	Yes, pulled down to under range.
S2 shorted to S3	Not implemented, Possible, monitor S2 voltage.
S1 and S2 open	Yes, pulled down to under range.
S1 and S3 open	Yes, S1 pulled up.
S2 and S3 open	Yes pulled up.
<b>Thermistor</b>	
S1 open	Yes, pulled up to sensor over range.
S3 open	Yes, pulled up to sensor over range.
S1 short to S3	Yes, pulled down to sensor under range.
S1 and S3 open	Yes, S1 pulled up to sensor over range.

# Modbus - Programmable Memory Blocks

## Assembly Definition Addresses and Assembly Working Addresses

Assembly Definition Addresses	Assembly Working Addresses	Assembly Definition Addresses	Assembly Working Addresses
40 & 41	200 & 201	80 & 81	240 & 241
42 & 43	202 & 203	82 & 83	242 & 243
44 & 45	204 & 205	84 & 85	244 & 245
46 & 47	206 & 207	86 & 87	246 & 247
48 & 49	208 & 209	88 & 89	248 & 249
50 & 51	210 & 211	90 & 91	250 & 251
52 & 53	212 & 213	92 & 93	252 & 253
54 & 55	214 & 215	94 & 95	254 & 255
56 & 57	216 & 217	96 & 97	256 & 257
58 & 59	218 & 219	98 & 99	256 & 259
60 & 61	220 & 221	100 & 101	260 & 261
62 & 63	222 & 223	102 & 103	262 & 263
64 & 65	224 & 225	104 & 105	264 & 265
66 & 67	226 & 227	106 & 107	266 & 267
68 & 69	228 & 229	108 & 109	268 & 269
70 & 71	230 & 231	110 & 111	270 & 271
72 & 73	232 & 233	112 & 113	272 & 273
74 & 75	234 & 235	114 & 115	274 & 275
76 & 77	236 & 237	116 & 117	276 & 277
78 & 79	238 & 239	118 & 119	278 & 279

### Assembly Definition Addresses Default Pointers

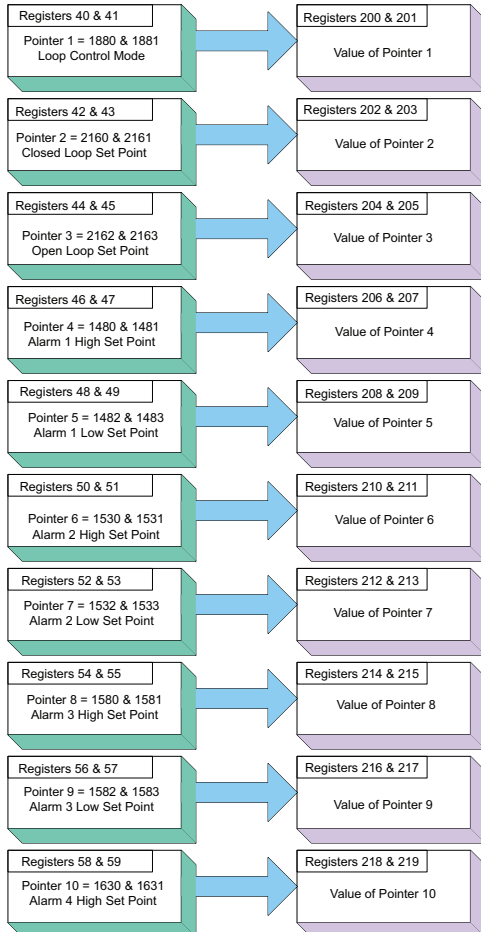

### Assembly Definition Addresses Default Pointers

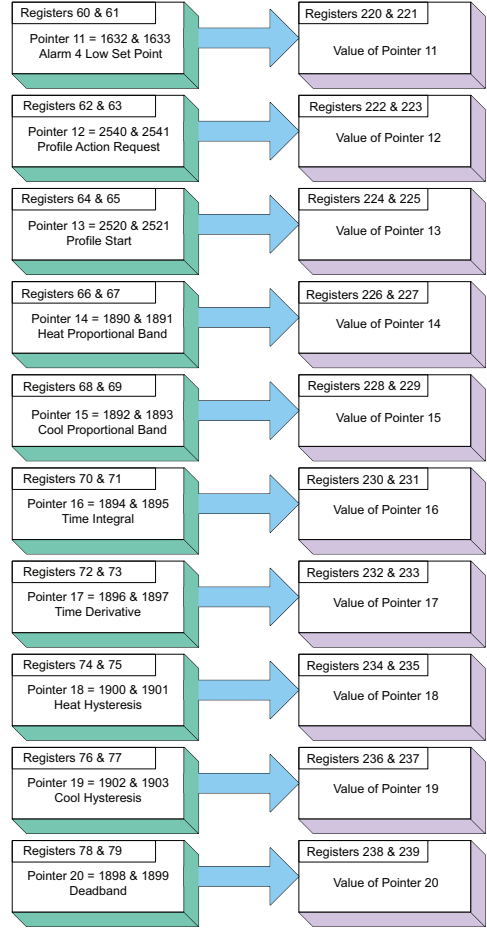

# Modbus Default Assembly Structure 80-119

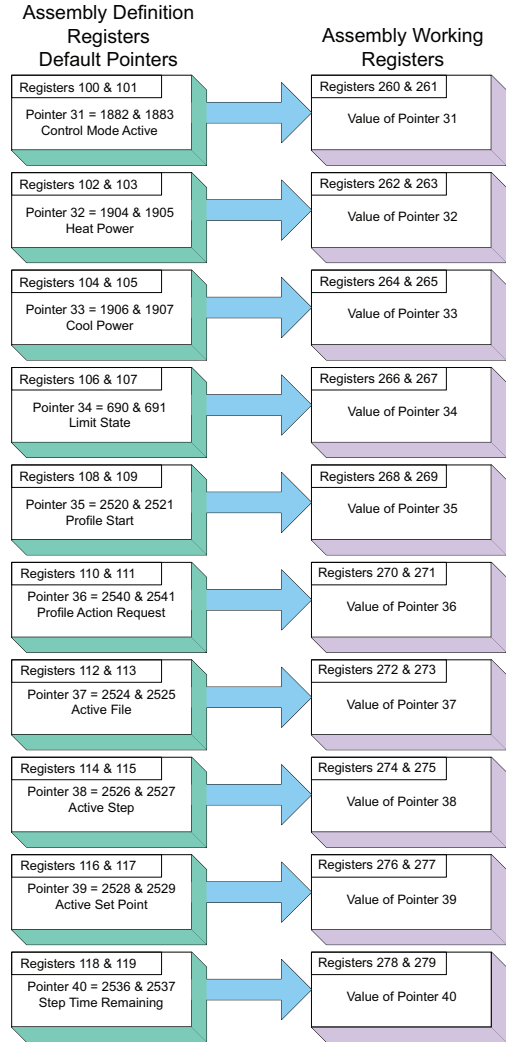
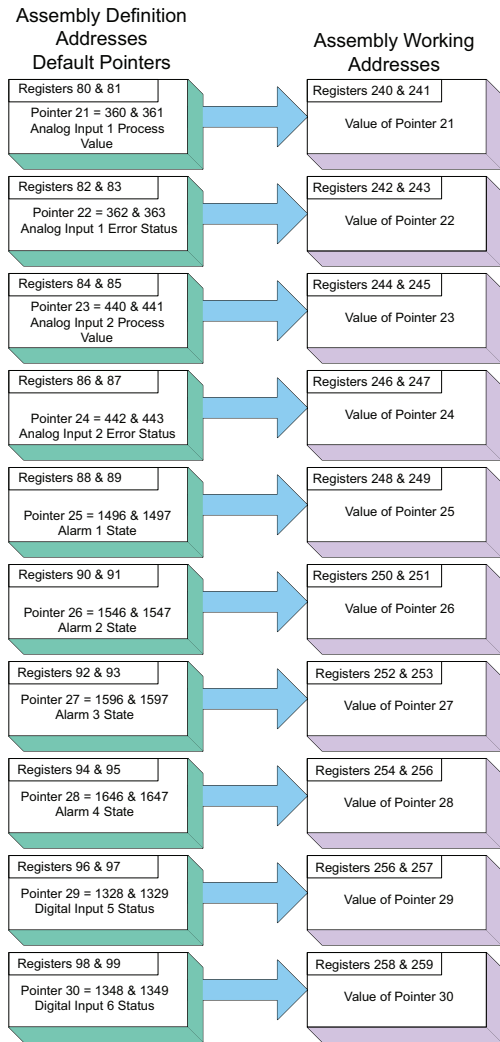

## CIP Implicit O to T (Originator to Target) Assembly Structure

CIP Implicit Assembly Originator (Master) to Target (PM)					
Assembly Members	PM Assembly Class, Instance, Attribute	PM Data Type	Parameter	Parameter Class, Instance, Attribute	PLC Data Type
1	0x77, 0x01, 0x01	DINT	Loop Control Mode	0x97, 0x01, 0x01	DINT
2	0x77, 0x01, 0x02	DINT	Closed Loop Set Point	0x6B, 0x01, 0x01	REAL
3	0x77, 0x01, 0x03	DINT	Open Loop Set Point	0x6B, 0x01, 0x02	REAL
4	0x77, 0x01, 0x04	DINT	Alarm 1 - Alarm High Set Point	0x6D, 0x01, 0x01	REAL
5	0x77, 0x01, 0x05	DINT	Alarm 1 - Alarm Low Set Point	0x6D, 0x01, 0x02	REAL
6	0x77, 0x01, 0x06	DINT	Alarm 2 - Alarm High Set Point	0x6D, 0x02, 0x01	REAL
7	0x77, 0x01, 0x07	DINT	Alarm 2 - Alarm Low Set Point	0x6D, 0x02, 0x02	REAL
8	0x77, 0x01, 0x08	DINT	Alarm 3 - Alarm High Set Point	0x6D, 0x03, 0x01	REAL
9	0x77, 0x01, 0x09	DINT	Alarm 3 - Alarm Low Set Point	0x6D, 0x03, 0x02	REAL
10	0x77, 0x01, 0x0A	DINT	Alarm 4 - Alarm High Set Point	0x6D, 0x04, 0x01	REAL
11	0x77, 0x01, 0x0B	DINT	Alarm 4 - Alarm Low Set Point	0x6D, 0x04, 0x02	REAL
12	0x77, 0x01, 0x0C	DINT	Profile Action Request	0x7A, 0x01, 0x0B	DINT
13	0x77, 0x01, 0x0D	DINT	Profile Start	0x7A, 0x01, 0x01	DINT
14	0x77, 0x01, 0x0E	DINT	Heat Proportional Band	0x97, 0x01, 0x06	REAL
15	0x77, 0x01, 0x0F	DINT	Cool Proportional Band	0x97, 0x01, 0x07	REAL
16	0x77, 0x01, 0x10	DINT	Time Integral	0x97, 0x01, 0x08	REAL
17	0x77, 0x01, 0x11	DINT	Time Derivative	0x97, 0x01, 0x09	REAL
18	0x77, 0x01, 0x12	DINT	Heat Hysteresis	0x97, 0x01, 0x0B	REAL
19	0x77, 0x01, 0x13	DINT	Cool Hysteresis	0x97, 0x01, 0x0C	REAL
20	0x77, 0x01, 0x14	DINT	Dead Band	0x97, 0x01, 0x0A	REAL

## CIP Implicit T to O (Target to Originator) Assembly Structure

CIP Implicit Assembly Target (PM) to Originator (Master)					
Assembly Members	PM Assembly Class, Instance, Attribute	PM Data Type	Parameter	Parameter Class, Instance, Attribute	PLC Data Type
1	Cannot be changed	Binary	Device Status	none	DINT
2	0x77, 0x02, 0x01	DINT	Analog Input 1, Analog Input Value	0x68, 0x01, 0x01	REAL
3	0x77, 0x02, 0x02	DINT	Analog Input 1, Input Error	0x68, 0x01, 0x02	REAL
4	0x77, 0x02, 0x03	DINT	Analog Input 2, Analog Input Value	0x68, 0x02, 0x01	REAL
5	0x77, 0x02, 0x04	DINT	Analog Input 2, Input Error	0x68, 0x02, 0x02	REAL
6	0x77, 0x02, 0x05	DINT	Alarm 1, Alarm State	0x6D, 0x01, 0x09	DINT
7	0x77, 0x02, 0x06	DINT	Alarm 2, Alarm State	0x6D, 0x02, 0x09	DINT
8	0x77, 0x02, 0x07	DINT	Alarm 3, Alarm State	0x6D, 0x03, 0x09	DINT
9	0x77, 0x02, 0x08	DINT	Alarm 4, Alarm State	0x09, 0x04, 0x09	DINT
10	0x77, 0x02, 0x09	DINT	Event Status	0x6E, 0x01, 0x05	DINT
11	0x77, 0x02, 0x0A	DINT	Event Status	0x6E, 0x02, 0x05	DINT
12	0x77, 0x02, 0x0B	DINT	Control Mode Active	0x97, 0x01, 0x02	DINT
13	0x77, 0x02, 0x0C	DINT	Heat Power	0x97, 0x01, 0x0D	REAL
14	0x77, 0x02, 0x0D	DINT	Cool Power	0x97, 0x01, 0x0E	REAL
15	0x77, 0x02, 0x0E	DINT	Limit State	0x70, 0x01, 0x06	DINT
16	0x77, 0x02, 0x0F	DINT	Profile Start	0x74, 0x01, 0x01	DINT
17	0x77, 0x02, 0x10	DINT	Profile Action Request	0x74, 0x01, 0x0B	DINT
18	0x77, 0x02, 0x11	DINT	Current Profile	0x74, 0x01, 0x03	DINT
19	0x77, 0x02, 0x12	DINT	Current Step	0x74, 0x01, 0x04	DINT
20	0x77, 0x02, 0x13	DINT	Active Set Point	0x74, 0x01, 0x05	REAL
21	0x77, 0x02, 0x14	DINT	Step Time Remaining	0x74, 0x01, 0x09	DINT

As can be seen on the previous page the PM Implicit Assembly defaults (factory settings) to a populated assembly structure. If it is desired to modify any of the given assembly members there are many software tools available to do so. It is outside of the scope of this document to describe how to use those. What can be found in this document is the *process* to build the assembly structure. If viewing this document electronically simply click on the link below to read the section entitled "[Modifying Implicit Assembly Members](#)". Otherwise, turn back to the table of contents to find the above named section.

## Compact Class Assembly Structure

On the next four pages the 17 available members of the Compact Class are displayed. As an orientation to the format as displayed in this document notice that each member begins with header identified as "Assembly" and below the header you will see the member number along with parameter information contained within. While looking at these illustrations keep in mind that each member is actually 32-bits in length. To better illustrate this information in this document, the following 6 pages present these members divided in half where the letter "A" in the page header and assembly number represents the most significant 16-bits where the letter "B" in the title and assembly number represents the least significant 16-bits of each member. In the event that these pages are printed out and then mixed up, simply match up the page headers placing them side by side. As an example, Compact Class 1 A through 7 A should be paired with Class 1 B through 7 B, left to right.

Assembly	Class, Instance, Attribute
1 A Analog Input Read	C = 0x71 (113) I = 1 to 4 A = 1

For further explanation as to what the Compact Class assembly is, navigate to the section entitled "[Compact Assembly Class](#)"



# Compact Class 1 A through 7 A

		Instance i															
Assembly	Class, Instance, Attribute	31	30	29	28	27	26	25	24	23	22	21	20	19	18	17	16
1 A Analog Input Read	C = 0x71 (113) I = 1 to 4 A = 1	Filtered Analog Input Value															

Bits 16 to 31, Signed 16 bits with implied tenths precision (-32768.8 to 3276.7)

		Instance i															
Assembly	Class, Instance, Attribute	31	30	29	28	27	26	25	24	23	22	21	20	19	18	17	16
2 A Control Read/Write	C = 0x71 (113) I = 1 to 4 A = 2	Closed Loop Set Point															

Bits 16 to 31, Signed 16 bits with implied tenths precision (-32768.8 to 3276.7)

		Instance i + 1															
Assembly	Class, Instance, Attribute	31	30	29	28	27	26	25	24	23	22	21	20	19	18	17	16
3 A Control Read/Write	C = 0x71 (113) I = 1 to 4 A = 3	Closed Loop Set Point															

Bits 16 to 31, Signed 16 bits with implied tenths precision (-32768.8 to 3276.7)

		Instance i															
Assembly	Class, Instance, Attribute	31	30	29	28	27	26	25	24	23	22	21	20	19	18	17	16
4 A Control Read/Write	C = 0x71 (113) I = 1 to 4 A = 4	Heat Proportional Band															

Bits 16 to 31, Unsigned 16 bits with implied tenths precision (0 to 6553.5)

		Instance i															
Assembly	Class, Instance, Attribute	31	30	29	28	27	26	25	24	23	22	21	20	19	18	17	16
5 A Control Read/Write	C = 0x71 (113) I = 1 to 4 A = 5	Cool Proportional Band (instance i)															

Bits 16 to 31, Unsigned 16 bits with implied tenths precision (0 to 6553.5)

		Instance i + 1															
Assembly	Class, Instance, Attribute	31	30	29	28	27	26	25	24	23	22	21	20	19	18	17	16
6 A Limit Read	C = 0x71 (113) I = 1 to 4 A = 6	Limit State	Input Error Status	Analog Input Value													

Bits 16 to 28, Signed 16 bits whole (-4096 to 4095)  
 Bit 29, Analog Input Error Status (0 = None, 1 = Error)  
 Bits 30 and 31, Limit State (00 = None, 01 = Low Limit, 10 = Limit High, 11 = Other)

		Instance i + 1															
Assembly	Class, Instance, Attribute	31	30	29	28	27	26	25	24	23	22	21	20	19	18	17	16
7 A Limit Read/Write	C = 0x71 (113) I = 1 to 4 A = 7	Spare	Limit Clear	Clear Latched Error	Analog Input Value												

Bits 16 to 28, Signed 13 bits whole (-4096 to 4095)  
 Bit 29, Clear Latched Input Error (0 = Ignore, 1 = Clear)  
 Bits 30, Limit Clear (0 = Ignore, 1 = Clear)

## Compact Class 1 B through 7 B

Instance i																
Assembly	15	14	13	12	11	10	9	8	7	6	5	4	3	2	1	0
1 B	Input Error Status	Loop Error Status	Actual Control Mode	Tune Status	Control Loop Output Power											
Bits 0 to 10, Signed 10 bits with implied tenths precision (-100.0 to 100.0) Bit 11, Loop Tuning Status (0 = Off, 1 = Anything Else) Bits 12 and 13, Actual Control Mode (00 = Off, 01 = Manual, 10 = Auto) Bit 14, Loop Error Status (0 = None, 1 = Error) Bit 15, Analog Input Error (0 = None, 1 = Error)																

Instance i																
Assembly	15	14	13	12	11	10	9	8	7	6	5	4	3	2	1	0
2 B	Spare	Open Loop Clear	Control Mode	Initiate Tune	Open Loop Set Point											
Bits 0 to 10, Signed 10 bits with implied tenths precision (-100.0 to 100.0) Bit 11, Initiate Tune (0 = No, 1 = Yes) Bits 12 and 13, Actual Control Mode (00 = Off, 01 = Manual, 10 = Auto) Bit 14, Open Loop Clear (0 = Ignore, 1 = Clear)																

Instance i																
Assembly	15	14	13	12	11	10	9	8	7	6	5	4	3	2	1	0
3 B	Closed Loop Set Point															
Bits 0 to 15, Signed 16 bits with implied tenths precision (-3276.8 to 3276.8)																

Instance i																
Assembly	15	14	13	12	11	10	9	8	7	6	5	4	3	2	1	0
4 B	Integral Time															
Bits 0 to 15, Unsigned 16 bits whole (0 to 65535)																

Instance i																
Assembly	15	14	13	12	11	10	9	8	7	6	5	4	3	2	1	0
5 B	Derivative Time															
Bits 0 to 15, Unsigned 16 bits whole (0 to 65535)																

Instance i																
Assembly	15	14	13	12	11	10	9	8	7	6	5	4	3	2	1	0
6 B	Limit State	Input Error Status	Analog Input Value													
Bits 0 to 12, Signed 13 bits whole (-4096 to 4095) Bits 13, Analog Input Error Status (0 = None, 1 = Error) Bit 14 and 15, Limit State (00 = None, 01 = Limit low, 10 = Limit high, 11 = Other)																

Instance i																
Assembly	15	14	13	12	11	10	9	8	7	6	5	4	3	2	1	0
7 B	Spare	Limit Clear	Clear Latched Error	Limit Set Point High												
Bits 0 to 12, Signed 13 bits whole (-4096 to 4095) Bit 13, Clear Latched Input Error (0 = Ignore, 1 = Clear) Bit 14, Limit Clear (0 = Ignore, 1 = Clear)																

## Compact Class 8 A through 13 A

		Instance i + 15		Instance i + 14		Instance i + 13		Instance i + 12		Instance i + 11		Instance i + 10		Instance i + 9		Instance i + 8	
Assembly	Class, Instance, Attribute	31	30	29	28	27	26	25	24	23	22	21	20	19	18	17	16
8 A Limit Read	C = 0x71 (113) I = 1 to 4 A = 8	Limit State		Limit State		Limit State		Limit State		Limit State		Limit State		Limit State		Limit State	

Bits 16 to 31, Paired bits representing the state of up to 16 limits (00 = None, 01 = Limit low,, 10 = Limit High)

		Instance i + 15		Instance i + 14		Instance i + 13		Instance i + 12		Instance i + 11		Instance i + 10		Instance i + 9		Instance i + 8	
Assembly	Class, Instance, Attribute	31	30	29	28	27	26	25	24	23	22	21	20	19	18	17	16
9 A Limit Read/Write	C = 0x71 (113) I = 1 to 4 A = 9	Spare	Limit Clear	Spare	Limit Clear	Spare	Limit Clear	Spare	Limit Clear	Spare	Limit Clear	Spare	Limit Clear	Spare	Limit Clear	Spare	Limit Clear

Bits 16 to 31, Paired bits representing the state of up to 16 limits (00 = None, 01 = Limit low,, 10 = Limit High)

		Instance i															
Assembly	Class, Instance, Attribute	31	30	29	28	27	26	25	24	23	22	21	20	19	18	17	16
10 A Limit Read/Write	C = 0x71 (113) I = 1 to 4 A = 0x0A (10)	Spare	Limit Clear	Clear Latched Error	Limit Set Point High												

Bits 16 to 28, Signed 13 bits whole (-4096 to 4095) - Bit 29, Clear Latched Input Error (0 = Ignore, 1 = Clear)

Bits 30, Limit Clear (0 = Ignore, 1 = Clear)

		Instance i + 1															
Assembly	Class, Instance, Attribute	31	30	29	28	27	26	25	24	23	22	21	20	19	18	17	16
11 A CT Read	C = 0x71 (113) I = 1 to 4 A = 0x0B (11)	Spare	Heater Error	Current Error	Current RMS												

Bits 16 to 28, Unsigned 11 bits (0 to 2047)

Bit 29, Current Error (00 = None, 01 = Low, 10 = High)

Bit 30, Heater Error (00 = None, 01 = Open, 10 = Shorted)

		Instance i + 15		Instance i + 14		Instance i + 13		Instance i + 12		Instance i + 11		Instance i + 10		Instance i + 9		Instance i + 8	
Assembly	Class, Instance, Attribute	31	30	29	28	27	26	25	24	23	22	21	20	19	18	17	16
12 A Alarm Read	C = 0x71 (113) I = 1 to 4 A = 0x0C (12)	Alarm State		Alarm State		Alarm State		Alarm State		Alarm State		Alarm State		Alarm State		Alarm State	

Bits 16 to 31, Paired bits reflecting the state of up to 16 alarms (00 = None, 01 = Alarm Low, 10 = Alarm High, 11 = Other)

		Instance i + 15		Instance i + 14		Instance i + 13		Instance i + 12		Instance i + 11		Instance i + 10		Instance i + 9		Instance i + 8	
Assembly	Class, Instance, Attribute	31	30	29	28	27	26	25	24	23	22	21	20	19	18	17	16
13 A Alarm Read/Write	C = 0x71 (113) I = 1 to 4 A = 0x0D (13)	Alarm Clear		Alarm Silence		Alarm Clear		Alarm Silence		Alarm Clear		Alarm Silence		Alarm Clear		Alarm Silence	

Bits 16 to 31, Paired bits reflecting the state of up to 16 alarms (0 = Ignore, 1 = Clear)

## Compact Class 8 B through 13 B

	Instance i + 7		Instance i + 6		Instance i + 5		Instance i + 4		Instance i + 3		Instance i + 2		Instance i + 1		Instance i	
Assembly	15	14	13	12	11	10	9	8	7	6	5	4	3	2	1	0
8 B	Limit State		Limit State		Limit State		Limit State		Limit State		Limit State		Limit State		Limit State	

Bits 0 to 15, Paired bits representing the state of up to 16 limits (00 = None, 01 = Limit low,, 10 = Limit High)

	Instance i + 7		Instance i + 6		Instance i + 5		Instance i + 4		Instance i + 3		Instance i + 2		Instance i + 1		Instance i	
Assembly	15	14	13	12	11	10	9	8	7	6	5	4	3	2	1	0
9 B	Spare	Limit Clear	Spare	Limit Clear	Spare	Limit Clear	Spare	Limit Clear	Spare	Limit Clear	Spare	Limit Clear	Spare	Limit Clear	Spare	Limit Clear

Bits 0, 2, 4, 6, 8, 10, 12 and 14, Limit Clear for instance i to instance i ( 0 = Ignore, 1 = Clear)

	Instance i															
Assembly	15	14	13	12	11	10	9	8	7	6	5	4	3	2	1	0
10 B	Spare				Limit Set Point Low											

Bits 0 to 12, Signed 13 bits whole (-4096 to 4095)

	Instance i															
Assembly	15	14	13	12	11	10	9	8	7	6	5	4	3	2	1	0
11 B	Spare	Heater Error	Current Error	Current RMS												

Bits 16 to 28, Unsigned 11 bits (0 to 2047)  
 Bit 29, Current Error (00 = None, 01 = Low, 10 = High)  
 Bit 30, Heater Error (00 = None, 01 = Open, 10 = Shorted)

	Instance i + 7		Instance i + 6		Instance i + 5		Instance i + 4		Instance i + 3		Instance i + 2		Instance i + 1		Instance i	
Assembly	15	14	13	12	11	10	9	8	7	6	5	4	3	2	1	0
12 B	Alarm State		Alarm State		Alarm State		Alarm State		Alarm State		Alarm State		Alarm State		Alarm State	

Bits 0 to 15, Paired bits reflecting the state of up to 16 alarms (00 = None, 01 = Alarm Low, 10 = Alarm High, 11 = Other)

	Instance i + 7		Instance i + 6		Instance i + 5		Instance i + 4		Instance i + 3		Instance i + 2		Instance i + 1		Instance i	
Assembly	15	14	13	12	11	10	9	8	7	6	5	4	3	2	1	0
13 B	Alarm Clear		Alarm Silence		Alarm Clear		Alarm Silence		Alarm Clear		Alarm Silence		Alarm Clear		Alarm Silence	

Bits 0 to 15, Paired bits reflecting the state of up to 16 alarms (0 = Ignore, 1 = Clear)

## Compact Class 14 A through 19 A

		Instance i															
Assembly	Class, Instance, Attribute	31	30	29	28	27	26	25	24	23	22	21	20	19	18	17	16
14 A Alarm Read/Write	C = 0x71 (113) I = 1 to 4 A = 0x0E (14)	Alarm Clear	Alarm Set Point High														
		Bits 16 to 30, Signed 15 bits with implied tenths precision (-1638.4 to 1638.3)															
		Bit 31, Alarm Clear (0 = Ignore, 1 = Clear)															

		Instance i + 1															
Assembly	Class, Instance, Attribute	31	30	29	28	27	26	25	24	23	22	21	20	19	18	17	16
15 A Analog Input Read	C = 0x71 (113) I = 1 to 4 A = 0x0F (15)	Input Error Status	Filtered Analog Input Value														
		Bits 16 to 30, Signed 15 bits with implied tenths precision (-1638.4 to 1638.3)															
		Bit 31, Analog Input Error (0 = None, 1 = Error)															

		Instance i + 1															
Assembly	Class, Instance, Attribute	31	30	29	28	27	26	25	24	23	22	21	20	19	18	17	16
16 A Analog Input Read	C = 0x71 (113) I = 1 to 4 A = 0x10 (16)	Filtered Analog Input Value															
		Bits 16 to 31, Signed 16 bits with implied tenths precision (-3276.8 to 3276.8)															

		Instance i + 15		Instance i + 14		Instance i + 13		Instance i + 12		Instance i + 11		Instance i + 10		Instance i + 9		Instance i + 8	
Assembly	Class, Instance, Attribute	31	30	29	28	27	26	25	24	23	22	21	20	19	18	17	16
17 A Analog Input Read	C = 0x71 (113) I = 1 to 4 A = 0x11 (17)	Spare	Input Error Status	Spare	Input Error Status	Spare	Input Error Status	Spare	Input Error Status	Spare	Input Error Status	Spare	Input Error Status	Spare	Input Error Status	Spare	Input Error Status
		Bits 16, 18, 20, 22, 24, 26, 28, 30, Analog Input Error Status (0 = None, 1 = Error)															

## Compact Class 14 B through 17 B

		Instance i															
Assembly		15	14	13	12	11	10	9	8	7	6	5	4	3	2	1	0
14 B	Alarm Silence	Alarm Set Point Low															

Bits 0 to 14, Signed 15 bits with implied tenths precision (-1638.4 to 1638.3)  
 Bit 15, Alarm Silence (0 = Ignore, 1 = Silence)

		Instance i															
Assembly		15	14	13	12	11	10	9	8	7	6	5	4	3	2	1	0
15 B	Input Error Status	Filtered Analog Input Value															

Bits 0 to 14, Signed 15 bits with implied tenths precision (-1638.4 to 1638.3)  
 Bit 15, Analog Input Error (0 = None, 1 = Error)

		Instance i															
Assembly		15	14	13	12	11	10	9	8	7	6	5	4	3	2	1	0
16 B		Filtered Analog Input Value															

Bits 0 to 15, Signed 16 bits with implied tenths precision (-3276.8 to 3276.8)

		Instance i + 7		Instance i + 6		Instance i + 5		Instance i + 4		Instance i + 3		Instance i + 2		Instance i + 1		Instance i	
Assembly		15	14	13	12	11	10	9	8	7	6	5	4	3	2	1	0
17 B	Spare	Input Error Status	Spare	Input Error Status	Spare	Input Error Status	Spare	Input Error Status	Spare	Input Error Status	Spare	Input Error Status	Spare	Input Error Status	Spare	Input Error Status	Input Error Status

Bits 0, 2, 4, 6, 8, 10, 12, 14, Analog Input Error Status(0 = None, 1 = Error)

# Specifications

## LineVoltage/Power (Minimum/Maximum Ratings)

- 85 to 264V~ (ac), 47 to 63Hz
- 20 to 28V~ (ac), 47 to 63Hz
- 12 to 40V= (dc)
- 14VA maximum power consumption (PM4, 8 & 9)
- 10VA maximum power consumption (PM3 & 6)
- Data retention upon power failure via non-volatile memory
- Compliant with SEMIF47-0200, FigureR1-1 voltage sag requirements @ 24V ~ (ac) or higher

## Environment

- 0 to 149°F (-18 to 65°C) operating temperature
- 40 to 185°F (-40to85°C) storage temperature
- 0 to 90%RH, non-condensing

## Accuracy

- Calibration accuracy and sensor conformity: ±0.1% of span, ±1°C @ the calibrated ambient temperature and rated line voltage
- Types R, S, B; 0.2%
- Type T below -50°C; 0.2%
- Calibration ambient temperature @ 77 ±5°F (25±3°C)
- Accuracy span :1000 °F (540°C) min.
- Temperature stability: ±0.1 °F/°F (±0.1°C/°C) rise in ambient max.

## Agency Approvals

- UL® Listed to UL® 61010-1 File E185611
- UL® Reviewed to CSA C22.2 No.61010-1-04
- UL® 50Type 4X, NEMA 4X indoor locations, IP66 front panel seal (indoor use only)
- FM Class 3545 File 3029084 temperature limit switches
- CE-See Declaration of Conformity RoHS and W.E.E.E. compliant
- ODVA-EtherNet/IP™ and DeviceNet Compliance
- CSA C22. No. 24 File 158031 Class 4813-02

## Isolated Serial Communications

- EIA 232/485, Modbus® RTU
- EtherNet/IP™, DeviceNet™ (ODVA certified)
- Modbus® TCP
- Profibus DP

## Wiring Termination—Touch-Safe Terminals

- Input, power and controller output terminals are touch safe removable 12 to 22 AWG

## Universal Input

- Thermocouple, grounded or ungrounded sensors
- >20MΩ input impedance
- 3μA open sensor detection
- Max. of 2KΩ source resistance
- RTD 2 or 3 wire, platinum, 100Ω and 1000Ω @ 0°C calibration to DIN curve (0.00385Ω/Ω/°C)
- Process, 0-20mA @ 100Ω ,or 0-10V =(dc) @ 20kΩ input impedance; scalable, 0-50mV, 0-1000Ω

### Voltage Input Ranges

- Accuracy ±10mV ±1 LSD at standard conditions
- Temperature stability ±100 PPM/°C maximum

### Milliamp Input Ranges

- Accuracy ±20μA ±1 LSD at standard conditions
- Temperature stability ±100 PPM/°C maximum

### Resolution Input Ranges

- 0 to 10V: 200 μV nominal
- 0 to 20 mA: 0.5 mA nominal

- Potentiometer: 0 to 1,200Ω
- Inverse scaling

Input Type	Max Error @ 25 Deg C	Accuracy Range Low	Accuracy Range High	Units
J	±1.75	0	750	Deg C
K	±2.45	-200	1250	Deg C
T (-200 to 350)	±1.55	-200	350	Deg C
N	±2.25	0	1250	Deg C
E	±2.10	-200	900	Deg C
R	±3.9	0	1450	Deg C
S	±3.9	0	1450	Deg C
B	±2.66	870	1700	Deg C
C	±3.32	0	2315	Deg C
D	±3.32	0	2315	Deg C
F (PTII)	±2.34	0	1343	Deg C
RTD, 100 ohm	±2.00	-200	800	Deg C
RTD, 1000 ohm	±2.00	-200	800	DegC
mV	±0.05	-50	50	mV
Volts	±0.01	0	10	Volts
mA dc	±0.02	0	20	mAmps DC
mA ac	±5	-50	50	mAmps AC
Potentiometer, 1K range	±1	0	1000	Ohms

Operating Range		
Input Type	Range Low	Range High
J	-210 °C	1200 °C
K	-270 °C	1371 °C
T	-270 °C	400 °C
N	-270 °C	1300 °C
E	-270 °C	1000 °C
R	-50 °C	1767 °C
S	-50 °C	1767 °C
B	-50 °C	1816 °C
C	0 °C	2315 °C
D	0 °C	2315 °C
F (PTII)	0 °C	1343 °C
RTD (100 ohm)	-200 °C	800 °C
RTD (1000 ohm)	-200 °C	800 °C
mV	-50	50
Volts	0	10
mAdc	0	20
mAac	-50	50
Potentiometer, 1K range	0	1200
Resistance, 5K range	0	5000
Resistance, 10K range	0	10000
Resistance, 20K range	0	20000
Resistance, 40K range	0	40000

## Thermistor Input

Input Type	Max Error @ 25 Deg C	Accuracy Range Low	Accuracy Range High	Units
Thermistor, 5K range	±5	0	5000	Ohms
Thermistor, 10K range	±10	0	10000	Ohms
Thermistor, 20K range	±20	0	20000	Ohms
Thermistor, 40K range	±40	0	40000	Ohms

- 0 to 40 KΩ, 0 to 20 KΩ, 0 to 10 KΩ, 0 to 5 KΩ
- 2.252 KΩ and 10 KΩ base at 77°F (25°C)
- Linearization curves built in
- Third party Thermistor compatibility requirements

Base R @ 25C	Alpha Techniques	Beta THERM	YSI	Prompt <input type="text" value="E.L"/>
2.252K	Curve A	2.2K3A	004	A
10K	Curve A	10K3A	016	B
10K	Curve C	10K4A	006	C

## 2 Digital Input/Output Option - 2 DIO

- Digital input update rate 10Hz
  - DC voltage
    - Max. input 36V<sub>DC</sub> @ 3 mA
    - Min. high state 3 V at 0.25 mA
    - Max. low state 2 V
  - Dry contact
    - Min. open resistance 10 KΩ
    - Max. closed resistance 50 Ω
    - Max. short circuit 20 mA
- Digital output update rate 10 Hz
  - Output voltage 24 V, current limit, Output 6 = 10mA max., Output 5 = 3 pole DIN-A-MITE<sup>®</sup> or 24mA max.

## Output Hardware

- Switched dc = 22 to 32V<sub>DC</sub> (dc) @ 30mA output 1 and 3, 10mA output 4
- Switched dc/open collector = 30V<sub>DC</sub> (dc) max. @ 100mA max. current sink
- Solid-State Relay (SSR), Form A, 0.5A @ 24V<sub>AC</sub> (ac) min., 264V<sub>AC</sub> (ac) max., opto-isolated, without contact suppression, 20 VA 120/240V<sub>AC</sub> (ac) pilot duty
- Electromechanical relay, Form C, 5A, 24 to 240V<sub>AC</sub> (ac) or 30V<sub>DC</sub> (dc) max., resistive load, 100,000 cycles at rated load, 125 VA pilot duty at 120/240V<sub>AC</sub> (ac), 25 VA at 24V<sub>AC</sub> (ac)
- Electromechanical relay, Form A, 5A, 24 to 240V<sub>AC</sub> (ac) or 30V<sub>DC</sub> (dc) max., resistive load, 100,000 cycles at rated load, 125 VA pilot duty at 120/240V<sub>AC</sub> (ac), 25 VA at 24V<sub>AC</sub> (ac)
- Universal process/retransmit, Output range selectable:
  - 0 to 10V<sub>DC</sub> (dc) into a min. 1,000Ω load
  - 0 to 20mA into max. 800Ω load

### Resolution

- dc ranges: 2.5mV nominal
- mA ranges: 5 μA nominal

### Calibration Accuracy

- dc ranges: ±15 mV
  - mA ranges: ±30 μA
- ### Temperature Stability
- 100 ppm/°C

## Operator Interface

- Dual 4 digit, 7 segment LED displays
- Advance, Reset, up and down keys, plus optional programmable EZ-KEY(s) depending on model size
- Typical display update rate 1Hz
- RESET key substituted for infinity on all models including the limit control

Dimensions				
Size	Behind Panel (max.)	Width	Height	Display Character Height
1/32	101.6 mm (4.00 in)	53.3 mm (2.10 in)	30.9 mm (1.22 in)	left: 7.59 mm (0.299 in) right: 5.90 mm (0.220 in)
1/4	100.8 mm (3.97 in)	100.3 mm (3.95 in)	100.3 mm (3.95 in)	up: 11.43 mm (0.450 in) middle: 9.53 mm (0.375 in) low: 7.62 mm (0.300 in)
1/16	101.6 mm (4.00 in)	53.3 mm (2.10 in)	53.3 mm (2.10 in)	up: 10.80 mm (0.425 in) low: 6.98 mm (0.275 in)
1/8 (H)	101.6 mm (4.00 in)	100.3 mm (2.10 in)	53.9 mm (1.22 in)	top: 11.4 mm (0.450 in) middle: 9.53 mm (0.375 in) bottom: 7.62 mm (0.300 in)
1/8 (V)	101.6 mm (4.00 in)	53.3 mm (2.10 in)	100.3 mm (3.95 in)	top: 11.4 mm (0.450 in) middle: 9.53 mm (0.375 in) bottom: 7.62 mm (0.300 in)

Weight	
1/32 DIN (PM3) • Controller: 127 g (4.5 oz.)	1/8 DIN (PM8&9) • Controller: 284 g (10 oz.)
1/16 DIN (PM6) • Controller: 186 g (6.6 oz.)	1/4 DIN (PM4) • Controller: 331 g (11.7 oz.)
User's Guide • 172.82 g (6.11 oz)	

Modbus<sup>®</sup> is a trademark of AEG Schneider Automation Inc.

EtherNet/IP<sup>™</sup> is a trademark of ControlNet International Ltd. used under license by Open DeviceNet Vendor Association, Inc. (ODVA).  
UL<sup>®</sup> is a registered trademark of Underwriters Laboratories Inc.  
DeviceNet<sup>™</sup> is a trademark of Open DeviceNet Vendors Association.

### Note:

These specifications are subject to change without prior notice.



# Ordering Information for Enhanced Limit Controller Models

## Enhanced Limit Controller

EZ-ZONE® Enhanced Limit Models  
 TRU-TUNE+® Adaptive Tune, red-green 7-segment displays

### Package Size

- 6 Panel Mount 1/16 DIN
- 8 Panel Mount 1/8 DIN Vertical
- 9 Panel Mount 1/8 DIN Horizontal
- 4 Panel Mount 1/4 DIN

### Primary Function

- L Limit Controller with Universal Input
- M Limit Controller with Thermistor
- D Custom Firmware

### Power Supply, Digital Input/Output

- 1 100 to 240V~ (ac)
- 2 100 to 240V~ (ac) plus 2 Digital I/O points
- 3 24V~ (ac) and 15 to 36V= (dc)
- 4 24V~ (ac) and 15 to 36V= (dc), plus 2 Digital I/O points

### Output 1 and 2 Hardware Options

#### Output 1

- AJ None
- CJ Switched dc/open collector
- EJ Mechanical relay 5 A, form C

#### Output 2

- Mechanical relay 5 A, form A
- Mechanical relay 5 A, form A
- Mechanical relay 5 A, form A

### Communications Options

- A None
- 1 EIA 485 Modbus RTU®
- 2 Modbus RTU 232/485
- 3 EtherNet/IP™, Modbus TCP
- 5 DeviceNet
- 6 Profibus

- Standard Bus EIA-485 always included - all models

### Future Options

- A None

### Output 3 and 4 Hardware Options

#### Output 3

- AA None
- AJ None
- AK None
- CA Switched dc/open collector
- CC Switched dc/open collector
- CJ Switched dc/open collector
- CK Switched dc/open collector
- EA Mechanical relay 5 A, form C
- EC Mechanical relay 5 A, form C
- EJ Mechanical relay 5 A, form C
- EK Mechanical relay 5 A, form C
- FA Universal Process
- FC Universal Process
- FJ Universal Process
- FK Universal Process
- KK Solid-State Relay 0.5 A, form A

#### Output 4

- None
- Mechanical relay 5 A, form A
- Solid-State Relay 0.5 A, form A
- None
- Switched dc
- Mechanical relay 5 A, form A
- Solid-State Relay 0.5 A, form A
- None
- Switched dc
- Mechanical relay 5 A, form A
- Solid-State Relay 0.5 A, form A
- None
- Switched dc
- Mechanical relay 5 A, form A
- Solid-State Relay 0.5 A, form A
- Solid-State Relay 0.5 A, form A

- PM6 only, if communications options 2 - 6 are ordered, option AA must be selected here.

### Isolated Input Option

- A None
- D Isolated Input 1

### Custom Options

- AA Standard EZ-ZONE face plate

P M - A A

## Note:

The model of controller that you have is one of many possible models in the EZ-ZONE PM family of controllers. To view the others, visit our website ([http://www.watlow.com/literature/pti\\_search.cfm](http://www.watlow.com/literature/pti_search.cfm)) and type EZ-ZONE into the Keyword field.

# Ordering Information for Limit Controller Models

## Limit Controller

EZ-ZONE® Limit Models  
 TRU-TUNE+® Adaptive Tune, red-green 7-segment displays

P M - A A A A A A

### Package Size

- 3 Panel Mount 1/32 DIN
- 6 Panel Mount 1/16 DIN
- 8 Panel Mount 1/8 DIN Vertical
- 9 Panel Mount 1/8 DIN Horizontal
- 4 Panel Mount 1/4 DIN

### Primary Function

- L Limit Controller with Universal Input
- M Limit Controller with Thermistor
- D Custom Firmware

### Power Supply, Digital Input/Output

- 1 100 to 240V~ (ac)
- 2 100 to 240V~ (ac) plus 2 Digital I/O points
- 3 24V~ (ac) and 15 to 36V= (dc)
- 4 24V~ (ac) and 15 to 36V= (dc), plus 2 Digital I/O points

### Output 1 and 2 Hardware Options

#### Output 1

- AJ None
- CJ Switched dc/open collector
- EJ Mechanical relay 5 A, form C

#### Output 2

- Mechanical relay 5 A, form A
- Mechanical relay 5 A, form A
- Mechanical relay 5 A, form A

### Communications Options

- A None
- 1 EIA 485 Modbus RTU®

- Standard Bus EIA-485 always included - all models

### Future Option

- AAA None

### Isolated Input Option

- A None
- D Isolated Input 1

### Custom Options

## Note:

The model of controller that you have is one of many possible models in the EZ-ZONE PM family of controllers. To view the others, visit our website ([http://www.watlow.com/literature/pti\\_search.cfm](http://www.watlow.com/literature/pti_search.cfm)) and type EZ-ZONE into the Keyword field.

# Index

- AbL** Alarm Blocking 56, 78
- ACLF** AC Line Frequency 58
- ACLR** Alarm Clear Request 57
- AdL** Alarm Delay 57
- AdSP** Alarm Display 57
- Ah** Alarm High Set Point 44, 56, 77
- AhY** Alarm Hysteresis 55, 78
- A** Analog Input Menu 42, 48
- Anb** Implicit Input Assembly 63
- Anb** Implicit Input Assembly Size 63
- ALA** Alarm Latching 56, 78
- ALE1 ALE2 ALE3 ALE4** Alarm Error 1 to 4  
Home Page 34
- AL9** Alarm Logic 55
- ALh1 ALh2 ALh3 ALh4** Alarm High 1 to 4  
Home Page 34
- ALL1 ALL2 ALL3 ALL4** Alarm Low 1 to 4  
Home Page 34
- ALP7** Alarm Menu 43, 55
- ALo** Alarm Low Set Point 43, 56, 77
- ALoc** Profibus Address Lock 61
- Aonb** Implicit Output Assembly 63
- Aonb** Implicit Output Assembly Size 63
- ASd** Alarm Sides 55
- AS** Alarm Silencing 56, 78
- ASr** Alarm Silence Request 57
- ASr** Alarm State 41, 57
- AttEn** Attention 34, 35
- AtY** Alarm Type 55, 77
- CAL** Calibration Menu 69
- CEr** Current Error 34
- CEr1** Current Error 34
- C\_F** Display Units 58, 63
- ChAn** Channel 59
- CLED** Communications LED Activity 58
- code** Public Key 70
- Code** Public Key 68
- CoP7** Communications Menu 59, 66
- CUSE** Custom Menu 36, 73
- dAEE** Date of Manufacture 68
- dEC** Decimal 49
- dio** Digital Input/Output Menu 42, 50
- d.r** Direction 50
- doS** Digital Output State 42
- dPrS** Display Pairs 47, 59
- dt** Display Time 59
- E,PE** Ethernet/IP™ Enable 63
- E,S** Event Input Status 42, 43
- ELo** Electrical Input Offset 70
- EL,S** Electrical Input Slope 70
- ELoO** Electrical Output Offset 70
- Er,1** Error Input  
Home Page 34
- F** Digital Output Function  
Instance 51
- F** Output Function Instance 53, 54
- F.L** Filter 49
- Fn** Output Function 53
- FUn** Function Key Menu 58
- GLbL** Global Menu 58
- hEr** Heater Error 34
- hEr1** Heater Error 34
- u,CA** Calibration Offset 42, 50, 73–74
- u,Er** Input Error Latching 49
- u,Er** Input Error Status 42, 50
- IPF1** IP Fixed Address Part 1 61, 69
- IPF2** IP Fixed Address Part 2 61, 69
- IPF3** IP Fixed Address Part 3 61, 69
- IPF4** IP Fixed Address Part 4 58, 59, 62, 69
- IP77** IP Address Mode 61, 68
- IP,S1** IP Fixed Subnet Part 1 62
- IP,S2** IP Fixed Subnet Part 2 62, 63
- LCr** Limit Clear Request 41
- LhY** Limit Hysteresis 52
- L,uE1** Limit Error 34
- L,h1** Limit High 34
- L,L1** Limit Low  
Home Page 34
- L,L1** Limit Low 34
- L,P7** Limit Menu 43, 52
- L.in** Linearization 48
- LLS** Limit Low Set Point 43, 52
- LoC** Security Setting Menu 66, 68
- LoCL** Locked Access Level 67
- LoCo** Lock Operations Page 66
- LoCP** Lock Profiling Page 66, 67, 68
- LSd** Limit Sides 52
- LSr** Limit State 41
- LSr** Limit Status 53
- P7AP** Data Map 63
- P7bE** Modbus TCP Enable 63
- P7u** Electrical Measurement 69
- nUS** Non-volatile Save 60
- nUS** Non-volatile Save 60, 64
- o,CA** Calibration Offset 54
- oPtE** Output Menu 53
- oTy** Output Type 53
- PAdd** Profibus Node Address 61
- PASr** Administrator Password 67
- PASrE** Display Pairs 66
- PASrE** Password Enable 66
- PASrS** Password 68
- PASru** User Password 67
- PEE** Process Error Enable 49
- PEL** Process Error Low 49
- Pn** Part Number 70
- Pn** Part Number 68
- rEv** Software Revision 68
- r,h** Range High 49, 54, 76
- r,Lo** Range Low 49, 54, 76
- rLoC** Read Lockout Security 67
- roLL** Rolling Password 67
- r,r** Thermistor Resistance  
Range 49
- r,tL** RTD Leads 48
- SbLd** Software Build 68
- SEn** Sensor Type 48, 75
- SFnA** Limit Reset Source Function 52
- Sh** Scale High 48, 54, 76
- S,r** Limit Source Reset Instance 52
- S,Lo** Scale Low 48, 54, 76
- SLoC** Set Lockout Security 67, 79, 80
- Sn** Serial Number 68
- t,C** Thermistor Curve 49
- uALh** Value to high 34
- USr,r** User Restore Set 59, 73
- USr,S** User Save Set 59
- uALL** Value to low 34
- ZonE** Zone 59

## A

- AC Line Frequency 58
- Active Process Value 36
- Address Modbus 59
- Address Standard Bus 59, 60, 63, 64
- Administrator Password 67
- agency approvals 3
- alarm blocking 78
- Alarm Error 1 to 4  
Home Page 34
- Alarm High 1 to 4  
Home Page 34
- Alarm Low 1 to 4  
Home Page 34
- Alarm Menu 43, 55
- alarms 77
- Blocking 56, 78
- Display 57
- Hysteresis 55, 78

- Latching 56, 78
- Logic 55
- process 77
- set points 77
- Sides 55
- Silencing 56, 78
- Source 55
- Type 55
- Analog Input Menu 42, 48
- Assembly Definition
  - Addresses 90
- Assembly Definition Addresses 81
- Assembly Definition Addresses and Assembly Working Addresses 90
- Assembly Working Addresses 81, 90
- attention codes 34
- Attention Codes 35
- B**
- Baud Rate 60
- Blocking 56, 78
- C**
- Calibration Menu 69
- Calibration Offset 42, 50, 54, 73–74
- changing the set point 35
- Channel 59
- chemical compatibility 15
- CIP - Communications Capabilities 82
- CIP Implicit Assemblies 82
- CIP Implicit O to T (Originator to Target) Assembly Structure 92
- CIP Implicit T to O (Target to Originator) Assembly Structure 92
- Common Industrial Protocol
  - CIP Implicit Assemblies 82
  - Compact Implicit Assembly Class 83, 93
  - Modifying Implicit Assembly Members 83
- Communications Menu 59, 66
  - Setup Page 41, 46
- Compact Assembly Class 83
- Compact Class Assembly Structure 93
- Control Module Menus
  - Factory Page
    - Calibration Menu 69
    - Security Setting Menu 66, 68
  - Operations Page
    - Alarm Menu 43
    - Analog Input Menu 42
    - Digital Input/Output Menu 42
    - Limit Menu 43
  - Setup Page
- Alarm Menu 55
- Analog Input Menu 48
- Communications Menu 59, 66
- Digital Input/Output Menu 50
- Global Menu 58
- Limit Menu 52
- Output Menu 53
- Custom Menu 73
- D**
- Data Map 63
- Date of Manufacture 68
- Decimal 49
- default Home Page parameters 33, 35
- Digital Input Function 5, 58
- Digital Input/Output Menu 42, 50
- digital inputs 5
- dimensions 11, 13
- Direction 50
- Display 57
- Display Pairs 36, 47, 59
- displays 33–34
- Display Time 59
- Display Units 58, 63
- Down Key 33
- d;prs] Display Pairs 36
- E**
- Electrical Input Offset 70
- Electrical Input Slope 70
- Electrical Measurement 69
- Electrical Output Offset 70
- Electrical Output Slope 70
- Error Input 1
  - Home Page 34
- Ethernet/IP™ Enable 63
- F**
- Factory Page 65
- Filter Time 49, 75
- filter time constant 75
- Function Instance 51
- G**
- Global Menu 58
  - Setup Page 41, 46
- H**
- high range 76
- high scale 76
- High Set Point
  - Alarm 44, 45, 56, 57, 77
  - Control Loop 75
- Home Page 35, 73
- Hysteresis 52, 55, 78
- I**
- Implicit Input Assembly Size 63
- Implicit Output Assembly Size 63
- Input Error Latching 49
- Input Error Status 42, 50
- input events 5
- inputs 4
- installation 14
- Instance 58
- IP Address Mode 61, 68
- IP Fixed Address Part 1 61, 69
- IP Fixed Address Part 2 61, 69
- IP Fixed Address Part 3 61, 69
- IP Fixed Address Part 4 58, 59, 62, 69
- IP Fixed Subnet Part 1 62
- IP Fixed Subnet Part 2 62, 63
- J**
- K**
- keys and displays
  - 1/16 DIN 33
- L**
- Latching 56, 78
- Level 58
- Limit Error 1 34
- Limit Low 1 or 2
  - Home Page 34
- Limit Menu 43, 52
- Linearization 48
- Locked Access Level 67
- Lockout Menu 79
- Logic 55
- low range 76
- low scale 76
- Low Set Point
  - Alarm 43, 56, 77
  - Control Loop 75
  - Limit 43, 52
- M**
- Message Action 34
- message, display 34
- Modbus Default Assembly Structure 80-119 91
- Modbus - Programmable Memory Blocks 90
- Modbus TCP Enable 63
- Modbus - Using Programmable Memory Blocks 81
- Modbus Word Order 60
- Modifying Implicit Assembly Members 83
- N**
- navigating
  - Factory Page 65
  - Setup Page 41, 46
- network wiring 31
- Non-volatile Save 47, 64

## O

Operations Page 41  
ordering information  
    enhanced limit controller models  
        102  
    limit controller models 103  
Output Function 53  
Output Menu 53  
outputs 4  
Output State 42  
Output Type 53

## P

P3T armor sealing system 3  
Parameter 1 to 20 66  
Parity 60  
Part Number 68, 70  
Password 68  
process alarms 77  
Process Error Enable 49  
Process Error Low 49  
Process Value 42, 50  
Profibus Address Lock 61  
Profibus DP 40  
Profibus DP - (Decentralized Peripherals) 83  
Profibus Node Address 61  
programming the Home Page 73  
Protocol 59  
Public Key 68, 70

## Q

## R

Range High 49, 54, 76  
Range Low 49, 54, 76  
Resetting a Tripped Limit 77  
responding to a displayed message  
    34–35  
restoring user settings 73  
retransmit 76  
Retransmit Source 53  
Rolling Password 67  
RTD Leads 48

## S

saving user settings 72  
Scale High 48, 54, 76  
Scale Low 48, 54, 76  
Security Setting 66, 68  
sensor selection 75  
Sensor Type 48, 75  
Serial Number 68  
set point high limit 75  
set point low limit 75  
Setup Page 46  
Sides  
    Alarm 55  
    Limit 52  
Silencing 56, 78

Software Build 68  
Software Revision 68  
Source 55

## T

temperature units indicator lights 33  
terminal functions 16–17  
Thermistor 48  
Type 55, 77

## U

upper display 33  
User Password 67  
User Restore Set 59, 73  
User Save Set 59, 73  
Using EZ-ZONE® Configurator Software 84

## V

## W

weight 101  
wiring  
    digital input or output 5 19  
    EIA-232/485 Modbus RTU communications 27  
    EtherNet/IP™ and Modbus TCP communications 27  
    high power 19  
    input 1 potentiometer 20  
    input 1 process 20  
    input 1 RTD 20  
    input 1 thermocouple 20  
    low power 19  
    Modbus RTU or Standard Bus EIA-485 communications 26  
    output 1 mechanical relay, form C 22  
    output 1 switched dc/open collector 21  
    output 2 mechanical relay, form A 23  
    output 2 switched DC/open collector 23  
    output 3 mechanical relay, form C 23  
    output 3 switched dc/open collector 23  
    output 3 universal process 24  
    output 4 mechanical relay, form A 25  
    output 4 solid-state relay, form A 25  
    output 4 switched DC/solid-state relay 24  
    Standard Bus EIA-485 communications 26  
wiring a network 31

## X

## Y

## Z

# Declaration of Conformity

## Series EZ-ZONE<sup>®</sup> PM



**WATLOW**  
1241 Bundy Blvd.  
Winona, MN 55987 USA

an ISO 9001 approved facility since 1996.

Declares that the following product:

Designation: **Series EZ-ZONE<sup>®</sup> PM (Panel Mount)**  
Model Numbers: PM (3, 6, 8, 9 or 4)(Any Letter or number) – (1, 2, 3 or 4)(A, C, E, F or K) (A, C, H, J or K)(Any letter or number) – (Any letter or number)(A, C, E, F or K)(A, C, H, J or K) (Any three letters or numbers)  
Classification: Temperature control, Installation Category II, Pollution degree 2, IP66  
Rated Voltage and Frequency: 100 to 240 V~ (ac 50/60 Hz) or 15 to 36 V= dc/ 24 V~ac 50/60 Hz  
Rated Power Consumption: 10 VA maximum PM3, PM6 Models.  
14 VA maximum PM8, PM9, PM4 Models

Meets the essential requirements of the following European Union Directives by using the relevant standards show below to indicate compliance.

<b>2004/108/EC Electromagnetic Compatibility Directive</b>		
<b>EN 61326-1</b>	<b>2006</b>	<b>Electrical equipment for measurement, control and laboratory use – EMC requirements (Industrial Immunity, Class B Emissions).</b>
EN 61000-4-2	1996 +A1,A2	Electrostatic Discharge Immunity
EN 61000-4-3	2006	Radiated Field Immunity 10V/M 80–1000 MHz, 3 V/M 1.4–2.7 GHz
EN 61000-4-4	2004	Electrical Fast-Transient / Burst Immunity
EN 61000-4-5	2006	Surge Immunity
EN 61000-4-6	1996 +A1,A2,A3	Conducted Immunity
EN 61000-4-11	2004	Voltage Dips, Short Interruptions and Voltage Variations Immunity
EN 61000-3-2	2006	Harmonic Current Emissions
EN 61000-3-3 <sup>1</sup>	2005	Voltage Fluctuations and Flicker
SEMI F47	2000	Specification for Semiconductor Sag Immunity Figure R1-1

<sup>1</sup>For mechanical relay loads, cycle time may need to be extended up to 160 seconds to meet flicker requirements depending on load switched and source impedance.

<b>2006/95/EC Low-Voltage Directive</b>		
<b>EN 61010-1</b>	<b>2001</b>	<b>Safety Requirements of electrical equipment for measurement, control and laboratory use. Part 1: General requirements</b>

### **Compliant with 2002/95/EC RoHS Directive**

Per 2002/96/EC W.E.E Directive  Please Recycle Properly.

Raymond D. Feller III  
Name of Authorized Representative

Winona, Minnesota, USA  
Place of Issue

General Manager  
Title of Authorized Representative

June 2009  
Date of Issue

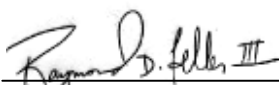
  
Signature of Authorized Representative

CE DOC EZ-ZONE PM-06-09

## How to Reach Us Corporate Headquarters

Watlow Electric Manufacturing Company  
12001 Lackland Road  
St. Louis, MO 63146  
Sales: 1-800-WATLOW2  
Manufacturing Support: 1-800-4WATLOW  
Email: [info@watlow.com](mailto:info@watlow.com)  
Website: [www.watlow.com](http://www.watlow.com)  
From outside the USA and Canada:  
Tel: +1 (314) 878-4600  
Fax: +1 (314) 878-6814

### Latin America

Watlow de México S.A. de C.V.  
Av. Fundación No. 5  
Col. Parques Industriales  
Querétaro, Qro. CP-76130  
Mexico  
Tel: +52 442 217-6235  
Fax: +52 442 217-6403

### Asia and Pacific

Watlow Singapore Pte Ltd.  
16 Ayer Rajah Crescent,  
#06-03/04,  
Singapore 139965  
Tel: +65 6773 9488 Fax: +65 6778 0323  
Email: [info@watlow.com.sg](mailto:info@watlow.com.sg) Website: [www.watlow.com.sg](http://www.watlow.com.sg)

Watlow Australia Pty., Ltd.  
4/57 Sharps Road  
Tullamarine, VIC 3043  
Australia  
Tel: +61 3 9335 6449  
Fax: +61 3 9330 3566  
Website: [www.watlow.com](http://www.watlow.com)

Watlow Electric Manufacturing Company (Shanghai) Co. Ltd.  
Room 501, Building 10, KIC Plaza  
290 Songhu Road, Yangpu District  
Shanghai, China 200433  
China  
Phone:  
Local: 4006 Watlow (4006 928569)  
International: +86 21 3381 0188  
Fax: +86 21 6106 1423  
Email: [vee@watlow.cn](mailto:vee@watlow.cn)  
Website: [www.watlow.cn](http://www.watlow.cn)

ワトロー・ジャパン株式会社  
〒101-0047 東京都千代田区内神田1-14-4  
四国ビル別館9階  
Tel: 03-3518-6630 Fax: 03-3518-6632  
Email: [infoj@watlow.com](mailto:infoj@watlow.com) Website: [www.watlow.co.jp](http://www.watlow.co.jp)

Watlow Japan Ltd.  
1-14-4 Uchikanda, Chiyoda-Ku  
Tokyo 101-0047  
Japan  
Tel: +81-3-3518-6630 Fax: +81-3-3518-6632  
Email: [infoj@watlow.com](mailto:infoj@watlow.com) Website: [www.watlow.co.jp](http://www.watlow.co.jp)

### Europe

Watlow France  
Tour d'Asnières.  
4 Avenue Laurent Cély  
92600 Asnières sur Seine  
France  
Tél: + 33 (0)1 41 32 79 70  
Télécopie: + 33(0)1 47 33 36 57  
Email: [info@watlow.fr](mailto:info@watlow.fr)  
Website: [www.watlow.fr](http://www.watlow.fr)

Watlow GmbH  
Postfach 11 65, Lauchwasenstr. 1  
D-76709 Kronau  
Germany  
Tel: +49 (0) 7253 9400-0  
Fax: +49 (0) 7253 9400-900  
Email: [info@watlow.de](mailto:info@watlow.de)  
Website: [www.watlow.de](http://www.watlow.de)

Watlow Italy S.r.l.  
Viale Italia 52/54  
20094 Corsico MI  
Italy  
Tel: +39 024588841  
Fax: +39 0245869954  
Email: [italyinfo@watlow.com](mailto:italyinfo@watlow.com)  
Website: [www.watlow.it](http://www.watlow.it)

Watlow Ibérica, S.L.U.  
C/Marte 12, Posterior, Local 9  
E-28850 Torrejón de Ardoz  
Madrid - Spain  
T. +34 91 675 12 92  
F. +34 91 648 73 80  
Email: [info@watlow.es](mailto:info@watlow.es)  
Website: [www.watlow.es](http://www.watlow.es)

Watlow UK Ltd.  
Linby Industrial Estate  
Linby, Nottingham, NG15 8AA  
United Kingdom  
Telephone: (0) 115 964 0777  
Fax: (0) 115 964 0071  
Email: [info@watlow.co.uk](mailto:info@watlow.co.uk)  
Website: [www.watlow.co.uk](http://www.watlow.co.uk)  
From outside The United Kingdom:  
Tel: +44 115 964 0777  
Fax: +44 115 964 0071

Watlow Korea Co., Ltd.  
#1406, E&C Dream Tower, 46, Yangpyeongdong-3ga  
Yeongdeungpo-gu, Seoul 150-103  
Republic of Korea  
Tel: +82 (2) 2628-5770 Fax: +82 (2) 2628-5771  
Website: [www.watlow.co.kr](http://www.watlow.co.kr)

Watlow Malaysia Sdn Bhd  
1F-17, IOI Business Park  
No.1, Persiaran Puchong Jaya Selatan  
Bandar Puchong Jaya  
47100 Puchong, Selangor D.E.  
Malaysia  
Tel: +60 3 8076 8745 Fax: +60 3 8076 7186  
Email: [vee@watlow.com](mailto:vee@watlow.com)  
Website: [www.watlow.com](http://www.watlow.com)

瓦特龍電機股份有限公司  
80143 高雄市前金區七賢二路189號 10樓之一  
電話: 07-2885168 傳真: 07-2885568

Watlow Electric Taiwan Corporation  
10F-1 No.189 Chi-Shen 2nd Road Kaohsiung 80143  
Taiwan  
Tel: +886-7-2885168 Fax: +886-7-2885568

### Your Authorized Watlow Distributor

